



# **STRAMIT EXACTA<sup>®</sup> C&Z PURLINS & GIRTS**

DESIGN CAPACITY  
TABLES AND  
MEMBER MOMENT  
CAPACITIES

product technical manual



# EXACTA<sup>®</sup> C&Z PURLINS

COMPREHENSIVE GUIDE TO  
SELECTING AND SPECIFYING  
STRAMIT EXACTA<sup>®</sup> PURLINS,  
GIRTS AND BRIDGING.



## IMPORTANT NOTE

The information contained within this brochure is as far as possible accurate at the date of publication, however, before application in a particular situation, Stramit Building Products recommends that you obtain qualified expert advice confirming the suitability of product(s) and information in question for the application proposed. While Stramit accepts its legal obligations, be aware however that to the extent permitted by law, Stramit disclaims all liability (including liability for negligence) for all loss and damage resulting from the use of the information provided in this brochure.

# Contents

## Introduction

How to Use	1
Complementary software	2
Related Literature	2
Copyright	2
Technical Support	2

## Selection/specification

Features & Benefits	2
Applications	2
Materials	2
Adverse Conditions	2
Compatibility	2
Specification	3
Tolerances	3
Downturn Lips	3

## Design Data

Sizes	3
Data Validity	4
Self Weight	4
Substitution by Standard Purlins	4
Section Properties	4
Suspended Loads	4
Local Pressure Factors	4
Point Loads	4
Bridging	4
Lap Lengths	4
Bolts	5
Holes	5
Cleats	5
Fascia Purlins	5
Cantilevers	5
Design Rules & Assumptions	5

## Design Capacity Tables

How to Use Design Capacity Tables	8
Section Properties	8
Span Configurations	8

## Design Member Moment Capacities

How to Use Moment Capacities	18
Segments	18

## Design Examples

22

## Procurement

Availability	29
Prices	29
Lengths	29

## Installation

29

## Additional Information

30

EX-facta™ Purlin Design Software Example	31
------------------------------------------	----

# Introduction

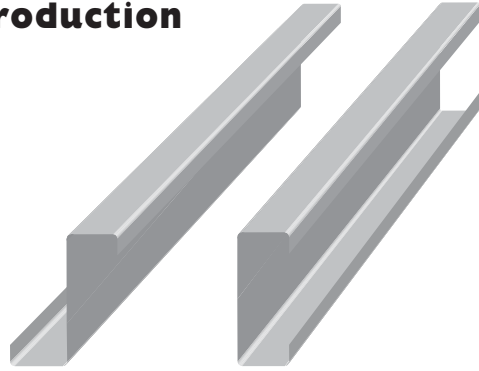

**Stramit Exacta® C&Z Purlins** come in sizes of 150, 200, 250, 300 and 350 are subtly but importantly different to standard **Stramit® Z&C Purlins**.

The distinction between the two types is that **Stramit Exacta® C&Z Purlins** have been performance optimised for the most commonly used spans. This simple change, enabled by Stramit's state-of-the-art manufacturing equipment and high standards of quality control, can lead to capacity improvements of up to 18%.

This **Stramit Exacta® C&Z Purlins** product technical supplement incorporates both design capacity tables (load tables) and design member moment capacities. The latter enables engineers to input properties and capacities into their preferred structural analysis software. With this capability it is practical to select purlin (and girt) configurations that are outside those listed in the design capacity tables. In particular it allows the analysis of irregular purlin configurations and complex loading patterns.

All data within this technical supplement are based on the limit state AS/NZS4600:2005 'Cold-formed Steel Structures'. Computations have been made using dedicated software developed by the University of Sydney. The procedures within the supplement show all of the design checks necessary in the calculation of purlins using the unique Member Moment Capacity method.

## How to Use

The procedure for using the **Stramit Exacta® C&Z Purlins and Girts** Product Technical Manual is largely self-explanatory. Please ensure that you are familiar with the assumptions and conditions by reading the manual fully. Once these are understood the basic sequence is:

1. Establish the required inward and outward loads, normally using ASI 170.
2. Turn to the design capacity tables for the preferred span configuration
3. Select a suitable purlin from the outward design capacity page (always the left-hand opening)
4. Check for inward capacity and deflection on the adjacent page at the same section, span and bridging case
5. Check that the bridging and bolt requirement is specified.

## Complementary Software

**Stramit**<sup>®</sup> has **EX-facta**<sup>™</sup> moment capacity design software available for alternative purlin span configurations. Spans can be mixed to any length and also include cantilevered ends. Even more importantly the software allows interactive repositioning of bridging positions, changing of lap lengths and mixing of section thicknesses to allow engineers to really optimise their purlin configurations. The **EX-facta**<sup>™</sup> program shows nominal section efficiencies within each span helping the user to visualise critical and over-designed sections. See pages 31 to 33 for worked example with screenshots.

## Related Literature

This document can be used in conjunction with **Stramit Exacta**<sup>®</sup> **C&Z Purlins and Girts and Bridging** detailing and installation guide which contains information on hole sizes, locations and punching, laps, expansion joints, accessories, bridging assembly options, detailing, procurement and installation for all Stramit<sup>®</sup> Purlins including **Stramit Exacta**<sup>®</sup> **C&Z Purlins**.

## Intellectual Property

This document is subject to copyright. The design method utilised within this manual is protected by patent.

## Technical Support

Stramit have Technical Service staff in each region of Australia to assist with all technical issues. This enables Stramit to provide advice that reflects local conditions and practices.

## Selection & Specification

### Features/Benefits

- High Tensile Steel – for high strength and low weight.
- Z350 Zinc Coating – for durable but economic protection.
- Available in the durable ZAM<sup>®</sup> coating for more severe environments.
- 150, 200, 250, 300, 350 sizes – a comprehensive range to cater for almost all applications.
- Full Thickness Range – with Stramit's proven record for manufacturing and supply.
- Integrated Bridging – boltless design specifically for Stramit<sup>®</sup> sections.
- Full range of Accessories – from brackets to bolts to ensure easy use and installation.
- Limit State Design in accordance with AS4600 – suitable for all government projects.
- Downturn Lip available – for projects requiring this feature.

## Applications

**Stramit Exacta**<sup>®</sup> **C&Z Purlins and Girts** are used to support roof or wall sheeting primarily in sheds and large industrial and commercial buildings. All uses of these sections require engineering design to ensure suitability.

## Materials

**Stramit Exacta**<sup>®</sup> **C&Z Purlins and Girts** are manufactured from galvanised hi-tensile steel, with a minimum Z350 galvanised coating (350g/m<sup>2</sup>) conforming to AS1397 and ZAM<sup>®</sup> coated steel. Other coatings, grades and materials may be available, subject to inquiry.

The mass and steel grade for each standard **Stramit Exacta**<sup>®</sup> **C&Z Purlin** section are shown in Table I below:

Table I

STRAMIT EXACTA <sup>®</sup> PURLINS – Mass and steel grade			
Section EC or EZ	Thickness (mm)	Strength (MPa)	Mass (kg/m)
150-10	1.0	G550	2.43
150-12	1.2	G500	2.90
150-15	1.5	G450	3.59
150-19	1.9	G450	4.51
150-24	2.4	G450	5.67
200-12	1.2	G500	3.63
200-15	1.5	G450	4.50
200-19	1.9	G450	5.74
200-24	2.4	G450	7.21
250-15	1.5	G450	5.18
250-19	1.9	G450	6.50
250-24	2.4	G450	8.17
300-19	1.9	G450	8.04
300-24	2.4	G450	10.2
300-30	3.0	G450	12.7
350-19	1.9	G450	9.68
350-24	2.4	G450	12.2
350-30	3.0	G450	15.2

## Adverse Conditions

**Stramit Exacta**<sup>®</sup> **C&Z Purlins and Girts** will give excellent durability in most applications. Galvanised hi-tensile steel is not recommended for use within 450mm of moist soil. Unwashed areas subject to salt-laden air or other corrosive matter may need additional protection. In many cases such protection can be provided by using ZAM<sup>®</sup> coating.

## Compatibility

Contact between **Stramit Exacta**<sup>®</sup> **C&Z Purlins and Girts** and copper (e.g., pipework) must be avoided as premature corrosion will occur.



## Specification

Maintaining the correct specification of purlins, girts and bridging is very important. Even a small change in specification can lead to substantial reduction in performance.

A suggested specification is:

“All purlins and girts shall be **Stramit Exacta® C or Z Purlins and Girts** used with **Stramit® Bridging** or approved equivalent, supported by submission of section properties, purlin capacity calculations, and a performance warranty, produced and detailed for this project. All sections shall be produced from (either - galvanised steel to AS1397 with a coating mass of at least 350g/m<sup>2</sup>, or ZAM® coated steel) and designed in accordance with AS4600:2005. All sections should be installed in accordance with the manufacturer’s instructions with particular regard to bridging and bolt locations and lap sizes.”

“Where required for structural or installation purposes, **Stramit® Bridging** shall be installed using pre-made components to manufacturer’s instructions. All other purlin accessories shall be supplied by Stramit.”

## Tolerances

All sections will be produced within the following tolerances:

Section length	+ 0mm / -10mm
Section web (dim. D)	+/- 1mm
Section flange (dim. B,E,F)	+/- 1mm
Internal flange angle	+/- 1°
Internal lip angles	+ 5° / -2°
Hole centres	+/- 1mm

**Table 2**

### STRAMIT EXACTA® C-PURLINS AND GIRTS – Size range

Section	Web D (mm)	Flange B (mm)	Thickness t (mm)	X <sub>c</sub> (mm)	X <sub>s</sub> (mm)
EC150-10	150	58	1.0	18.2	46.7
EC150-12	150	58	1.2	18.3	46.8
EC150-15	150	58	1.5	18.3	47.0
EC150-19	150	58	1.9	18.4	47.2
EC150-24	150	58	2.4	18.5	47.6
EC200-12	200	72	1.2	20.0	52.1
EC200-15	200	72	1.5	20.1	52.2
EC200-19	200	72	1.9	20.8	54.2
EC200-24	200	72	2.4	20.9	54.5
EC250-15	250	73	1.5	18.5	49.5
EC250-19	250	73	1.9	18.5	49.4
EC250-24	250	73	2.4	18.7	50.0
EC300-19	300	93	1.9	24.5	64.8
EC300-24	300	93	2.4	24.6	65.1
EC300-30	300	93	3.0	25.3	67.1
EC350-19	350	120	1.9	32.4	84.5
EC350-24	350	120	2.4	32.5	84.9
EC350-30	350	120	3.0	32.7	85.3

## Downturn Lips

All **Stramit Exacta® C or Z Purlins and Girts** may be available with downturn lips for special projects. Purlins of this shape cannot normally be lapped and are usually used in single or short double span construction. However, Stramit can supply “lappable” Z’s, subject to inquiry, providing a unique section that offers strength and economy as well as downturned lip. Please contact your local Stramit office for details on capacity, availability, minimum order quantity and delivery lead times.

Remember to allow additional cleat length for clearance between the downturn lips and the support beam.

## Design Data

### Sizes

The tables below list the sizes and thicknesses of **Stramit Exacta® C&Z Purlins and Girts**.

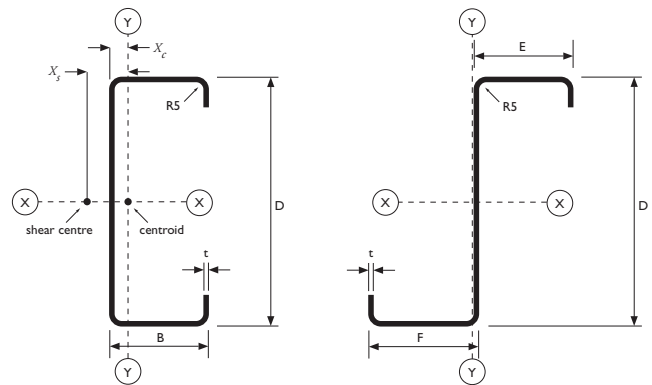

**Table 3**

### STRAMIT EXACTA® Z-PURLINS AND GIRTS – Size range

Section	Web D (mm)	Flange E (mm)	Flange F (mm)	Thickness t (mm)
EZ150-10	150	57	61	1.0
EZ150-12	150	57	61	1.2
EZ150-15	150	57	61	1.5
EZ150-19	150	57	61	1.9
EZ150-24	150	57	61	2.4
EZ200-12	200	69	74	1.2
EZ200-15	200	69	74	1.5
EZ200-19	200	69	74	1.9
EZ200-24	200	69	74	2.4
EZ250-15	250	71	76	1.5
EZ250-19	250	71	76	1.9
EZ250-24	250	71	76	2.4
EZ300-19	300	91	98	1.9
EZ300-24	300	91	98	2.4
EZ300-30	300	91	98	3.0
EZ350-19	350	116	124	1.9
EZ350-24	350	116	124	2.4
EZ350-30	350	116	124	3.0

### Data Validity

Designs generated using this technical manual are only valid for use with **Stramit Exacta® C&Z Purlins, Girts & Stramit® Bridging**. Important assumptions are made in deriving this data regarding product tolerances, materials and components used, which may not be valid if other products are used. Therefore, if designs are based on this data, **Stramit Exacta® C&Z Purlins, Girts & Stramit® Bridging** must be specified and used.

### Self Weight

The capacity tables in this manual make no allowance for self-weight of the purlins, sheeting or any other materials or components. These must therefore be accounted for in the derivation of loadings and actions.

### Standard Purlins

Designs based on this technical manual and also using **EX-facta™** design software are strictly only applicable for **Stramit Exacta® C&Z Purlins and Girts**.

WARNING - Do not substitute standard purlins from Stramit or other manufacturers for designs based on this manual. Such structures would be under-designed and may be unsafe.

### Section Properties

The section properties given in Tables 6, 7 and 8, 9 are subject to slight variation due to mathematical rounding and commercial tolerances on dimensions (note, however, that total material used will not vary). Any designs carried out using these properties should be calculated using AS/NZS4600. Whilst AS/NZS4600 requires many more section properties, those shown in the tables are the only ones obtainable without reference to the particular application. When inputting section properties for laps always use the sum of the properties for each of the lapped purlins. Never use properties for an equivalent single section of the combined thickness (e.g. for lapped EZ150-12 purlins use 2x the values for that purlin, do not use the properties of a EZ150-24 purlin).

### Suspended Loads

Loads to be suspended from roof purlins must be accounted for in design. No allowance is included in the capacity tables. Any such loadings must be connected to the purlin web by using hangers or other means. Never attach loads to the purlin lips. Attachments to the purlin flange must be within 25mm of the web. Connection design should follow the rules within AS/NZS4600, including a check on bearing of the purlin. Loads should not be suspended from wall girts.

### Local Pressure Factors

The capacity tables in this manual do not account for local pressure factors for wind. Partial and variable loads can easily be input into **EX-facta™** design software.

### Point Loads

The capacity tables in this manual do not account for point loads. Point loads can easily be input into **EX-facta™** design software.

### Bridging

Bridging provides resistance to purlin rotation during the installation of roof and wall sheeting. For this reason a maximum bridging (or bridging to cleat) spacing of 20 x purlin depth, but no greater than 4000, is recommended. Failure to do so can lead to misaligned fastenings, causing additional stresses on the fasteners and roof sheeting. Excessive purlin rotation can be a safety hazard during construction. Stramit therefore recommends that at least one row of bridging be used in each purlin span. Span/bridging configurations which exceed these recommendations are shown on the left of or above the red line. However in instances where sheeting is successfully installed outside of this recommendation the published values are valid for structural purposes.

**Stramit® Bridging** is only designed to allow purlins and girts to resist wind loads once the sheeting has been attached. Purlins, girts and bridging should not be subjected to loading from stacked materials, even when sheeting is attached, or from lifting assemblies of framing.

### Laps

Stramit generally recommends a lap length of 15% of the span. Lapped span Design Capacity tables (including continuous) are based on a 15% lap. Where span lengths are unequal (e.g. reduced end spans) each purlin should have 7.5% of each adjacent span added rather than 7.5% of that purlin's span.

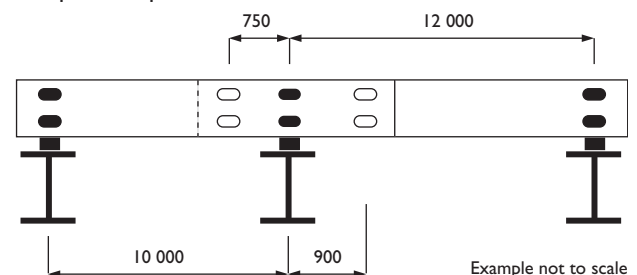

The lap length can however be varied using the Member Moment methodology in this supplement, including lap lengths that are different on either side of a support. This can be particularly useful where say one purlin in a long run is just short of capacity.

Lap lengths of less than 10% (or 5% on any side of a support) may not provide full structural continuity and may also suffer from local failures not considered by this method. They must therefore be considered beyond the scope of this manual.

### Bolts

Bolting of **Stramit Exacta® C&Z Purlins** or **Girts** to cleats and at lapped joints should be by standard M12 grade 4.6 bolts unless the shear capacity of the bolts is exceeded as indicated in the design capacity tables. These cases, shown in bold italics, require grade 8.8 bolts to be used. It is however possible to use grade 4.6 bolts provided the reaction values shown in the tables below are not exceeded. For 300 series purlins, use M16 bolts or M16 grade 8.8 bolts where indicated.

**Table 4**

<b>STRAMIT EXACTA® PURLINS – Bolt Reaction</b>	
Bolt Size & Grade	Bolt Shear Capacities $\phi V_{vf}$ (kN)
2 x M12/4.6	30.3
2 x M12/8.8	62.8
2 x M16/4.6	57.2
2 x M16/8.8	118.7

### Holes

**Stramit Exacta® C&Z Purlins and Girts** are custom punched to requirements. Standard hole size is 18mm x 22mm. Recommended web hole centres are:

EZ/EC 150	60mm
EZ/EC 150	70mm (Vic & Tas)
EZ/EC 200	110mm
EZ/EC 250	160mm
EZ/EC 300	210mm
EZ/EC 350	210mm

### Cleats

Single cleats are used in most situations, including lapped Z purlins. Double cleats are generally only used where successive purlins (usually unlapped) are butted together. Double cleats could also be used in applications with a high reaction load, to reduce bolt stresses. In this situation, additional care would be needed in hole detailing.

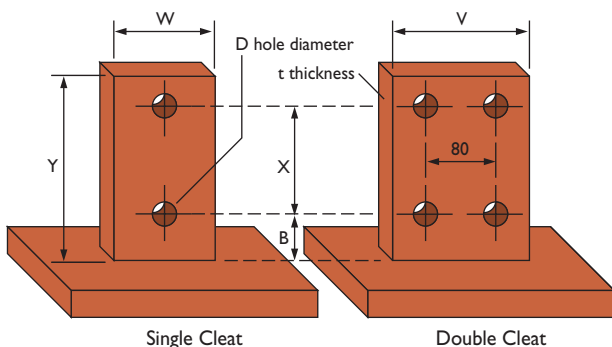

The table below shows industry standard recommended cleat sizes, including purlin clearances.

**Table 5**

<b>CLEAT NOMINAL DIMENSIONS (mm)</b>								
Section	X	B <sup>†</sup>	Y <sup>†</sup>	t	Gap	D	W	V
100	40	40	105	8	10	18	50	130
150	60*	55**	145	8	10	18	60	140
200	110	55	195	8	10	18	60	140
250	160	55	245	8	10	18	60	140
300	210	65	305	12	20	22	60	140
350	260	65	355	12	20	22	60	140

\*70mm in Victoria

\*\*50mm in Victoria

†When using downturn lip purlins or girts the lip length must be added to dimension B and Y.

Cleat length may need to be increased in some design situations (e.g., above an expansion joint). As a guide, increase the cleat thickness by 2mm for each 40mm of additional length.

For downturn lipped purlins always add at least the lip length to the cleat height. Also the cleat thickness may need to be increased to allow for the increased bending moment due to purlin asymmetry.

### Fascia Purlins

Fascia purlins (either specifically designed or **Stramit Exacta® C-Purlin**) are normally subjected to lower loads and are usually restrained by sheeting attached on the top flange and lower lip. However should the fascia purlin support the wall girts, via the fascia bridging system, ensure sufficient allowance is made to carry this extra load.

### Cantilevers

The capacity of cantilevers is, in part, dependent on the adjacent internal span length. The number of consequent permutations precludes the inclusion of tabulated data. It has been found however that cantilevers of up to 20% of the adjacent internal span length will generally be within the capacity of that section, provided the cantilever ends are braced against rotation and lateral movement. Cantilevers can readily be input into **EX-facto™** design software.

### Design Rules/Assumptions

In all cases in this manual the span referred to is the distance between centres of the cleat bolts at each end of the purlin. Each span type represents a complete purlin run system and recognises that using separate component parts (e.g. internal span, end span) is not a valid procedure.

Limit-state design capacities have been calculated in accordance with the provisions of AS/NZS4600 and may be limited by yielding, combined bending and web shear, flexural-torsional buckling, distortional buckling, bearing or bolt shear.

Capacities vary with direction of loading, span type and number of bridging rows, and apply equally to **Stramit Exacta® C&Z Purlins or Girts**. Fabrication and erection must be carried out in accordance with Stramit's recommendations and good trade practice. It is assumed that cladding substantially prevents lateral deflection of the flange to which it is attached and that bridging, where used, prevents both lateral deflection and rotation of the section at that point. Where bridging is required the data is only valid if **Stramit® Bridging** is used. Purlins must be bolted to cleats or other rigid structure providing full web

support at every support position. The tables do not take account of the ability of particular roof sheeting or wall cladding to carry the loads published; reference should be made to separate load information which is available for all Stramit® cladding profiles. Any conditions not strictly in accordance with those laid out in these notes should be referred to your regional Stramit Technical Services Manager.

Deflections are based on common practice for industrial buildings, which is to limit maximum deflection to the span divided by 150 (L/150). The tables show the load value at

**Table 6**

<b>STRAMIT EXACTA® Z-PURLINS AND GIRTS – FULL SECTION PROPERTIES</b>												
Section	Area $A_g$ (mm <sup>2</sup> )	$A_n^{\#}$ (mm <sup>2</sup> )	$I_x$ (10 <sup>6</sup> mm <sup>4</sup> )	$I_y$ (10 <sup>6</sup> mm <sup>4</sup> )	$Z_x$ (10 <sup>3</sup> mm <sup>3</sup> )	$Z_y$ (10 <sup>3</sup> mm <sup>3</sup> )	$r_x$ (mm)	$r_y$ (mm)	$\beta_x$ (mm)	$\beta_y$ (mm)	$J$ (mm <sup>4</sup> )	$I_w$ (10 <sup>9</sup> mm <sup>6</sup> )
EZ150-10	295	224	1.03	0.25	13.6	4.15	59.1	28.9	12.9	12.4	98.4	0.96
EZ150-12	354	268	1.23	0.30	16.2	5.00	59.0	29.0	13.0	12.4	170	1.15
EZ150-15	443	336	1.53	0.37	20.2	6.28	58.8	29.0	13.0	12.3	332	1.45
EZ150-19	561	425	1.93	0.47	26.0	8.01	58.6	29.0	13.0	12.3	675	1.84
EZ150-24	707	539	2.41	0.59	31.6	10.1	58.3	28.9	13.1	12.2	1358	2.30
EZ200-12	444	358	2.72	0.49	26.9	6.77	78.3	33.2	18.2	16.8	213	3.38
EZ200-15	556	448	3.39	0.61	33.5	8.51	78.2	33.2	18.2	16.7	417	4.24
EZ200-19	713	577	4.33	0.83	42.7	11.5	77.9	34.0	18.2	16.3	859	5.77
EZ200-24	901	731	5.43	1.05	53.6	14.6	77.6	34.1	18.2	16.2	1731	7.32
EZ250-15	638	530	5.85	0.67	46.2	8.99	95.7	32.3	22.6	19.4	479	7.50
EZ250-19	808	671	7.38	0.85	58.4	11.5	95.5	32.4	22.6	19.3	973	9.53
EZ250-24	1021	848	9.28	1.08	73.4	14.6	95.3	32.5	22.7	19.2	1962	12.1
EZ300-19	998	831	13.4	1.77	88.2	18.6	115	42.1	29.4	25.7	1201	28.2
EZ300-24	1261	1050	16.9	2.24	111	23.7	115	42.1	29.5	25.6	2422	35.8
EZ300-30	1593	1329	21.2	2.94	139	31.2	115	42.9	29.5	25.0	4780	47.2
EZ350-19	1207	1040	22.6	3.58	128	29.5	137	54.4	30.3	27.7	1452	76.1
EZ350-24	1525	1314	28.5	4.54	161	37.5	137	54.5	30.4	27.6	2929	96.4
EZ350-30	1908	1644	35.5	5.70	200	47.3	136	54.7	30.5	27.6	5725	121

# Includes area reduction for four (2 web & 2 flange) adjacent standard holes (18mm x 22mm or 18mm diameter).

**Table 7**

<b>STRAMIT EXACTA® Z-PURLINS AND GIRTS – EFFECTIVE SECTION PROPERTIES</b>			
Section	$Z_e$ (10 <sup>3</sup> mm <sup>3</sup> )	$y_c$ (mm)	$A_e$ (mm <sup>2</sup> )
EZ150-10	9.79	85.9	142
EZ150-12	13.4	81.3	192
EZ150-15	18.1	78.5	273
EZ150-19	24.4	76.6	401
EZ150-24	32.2	75.0	580
EZ200-12	18.1	118	194
EZ200-15	26.6	110	281
EZ200-19	38.3	105	417
EZ200-24	51.5	102	615
EZ250-15	33.5	143	286
EZ250-19	48.5	135	406
EZ250-24	74.2	125	592
EZ300-19	64.2	171	454
EZ300-24	93.0	161	644
EZ300-30	129	156	940
EZ350-19	81.3	210	494
EZ350-24	117	200	700
EZ350-30	167	188	985

NOTES: 1.  $Z_e$  effective section modulus at yield stress (bending). 2.  $y_c$  depth to neutral axis top fibre (bending). 3.  $A_e$  effective area at yield stress (compression).



which that deflection is reached. Deflection limits shown in the Inwards Tables are applicable to both inwards and outwards loading. The deflection is for all practical purposes proportional to the load applied, and so calculation of alternative deflection limits requires only simple arithmetic.

All capacities shown are for uniformly distributed loads only and do not include allowance for the self-mass of the purlins, sheeting or other roof components. Capacities are valid only when sheeting and bridging are completely attached. Great care must therefore be taken to ensure

that loads encountered during erection can be accommodated. Direction of loading has been assumed to be parallel with the Y-Y axis of the purlin (parallel to the web). Intermediate values may be obtained from the design capacity tables by linear interpolation, within the span range shown.

Where required, combined axial and bending loading capacity should be calculated using the Member Moment Capacity tables. This capacity is affected by, and should be designed with regard to eccentric loadings, the amount of bridging in the system and the roof sheeting.

**Table 8**

<b>STRAMIT EXACTA® C-PURLINS AND GIRTS – FULL SECTION PROPERTIES</b>											
Section	Area $A_g$ (mm <sup>2</sup> )	$A_n^{\#}$ (mm <sup>2</sup> )	$I_x$ (10 <sup>6</sup> mm <sup>4</sup> )	$I_y$ (10 <sup>6</sup> mm <sup>4</sup> )	$Z_x$ (10 <sup>3</sup> mm <sup>3</sup> )	$Z_y$ (10 <sup>3</sup> mm <sup>3</sup> )	$r_x$ (mm)	$r_y$ (mm)	$\beta_y$ (mm)	$J$ (mm <sup>4</sup> )	$I_w$ (10 <sup>9</sup> mm <sup>6</sup> )
EC150-10	296	224	1.03	0.15	13.7	3.69	59.1	22.4	163	98	0.73
EC150-12	354	268	1.23	0.18	16.4	4.44	59.0	22.4	163	170	0.88
EC150-15	444	336	1.53	0.22	20.4	5.57	58.8	22.4	162	332	1.11
EC150-19	562	425	1.93	0.28	25.7	7.10	58.6	22.4	161	675	1.42
EC150-24	712	539	2.41	0.35	32.1	9.03	58.3	22.3	160	1362	1.82
EC200-12	444	358	2.72	0.31	27.2	6.09	78.2	26.2	214	213	2.49
EC200-15	556	448	3.39	0.38	33.8	7.65	78.1	26.2	213	416	3.13
EC200-19	714	577	4.32	0.51	43.2	10.3	77.8	26.6	211	858	4.34
EC200-24	904	731	5.42	0.64	54.2	13.1	77.5	26.6	209	1731	5.54
EC250-15	638	530	5.84	0.44	46.7	8.24	95.6	26.3	267	478	5.49
EC250-19	806	669	7.35	0.55	58.8	10.3	95.4	26.2	266	970	6.89
EC250-24	1021	848	9.27	0.71	74.1	13.3	95.2	26.3	263	1961	8.91
EC300-19	998	831	13.4	1.15	89.2	17.0	115	33.9	318	1201	20.7
EC300-24	1261	1050	16.8	1.45	112	21.6	115	33.9	316	2422	26.3
EC300-30	1593	1329	21.2	1.88	141	28.4	115	34.3	312	4780	35.1
EC350-19	1207	1040	22.6	2.31	129	26.6	137	43.7	376	1452	55.7
EC350-24	1525	1314	28.5	2.92	163	33.8	137	43.7	375	2929	70.9
EC350-30	1908	1644	35.5	3.65	203	42.6	136	43.7	373	5725	89.3

# Includes area reduction for four (2 web & 2 flange) adjacent standard holes (18mm x 22mm or 18mm diameter).

**Table 9**

<b>STRAMIT EXACTA® C-PURLINS AND GIRTS – EFFECTIVE SECTION PROPERTIES</b>			
Section	$Z_e$ (10 <sup>3</sup> mm <sup>3</sup> )	$y_c$ (mm)	$A_e$ (mm <sup>2</sup> )
EC15010	9.71	86.1	141
EC15012	13.7	80.5	196
EC15015	18.4	77.9	279
EC15019	25.0	75.7	418
EC15024	31.9	75.0	580
EC20012	17.9	118	192
EC20015	26.3	111	278
EC20019	38.1	105	414
EC20024	51.0	103	607
EC250-15	33.9	142	289
EC250-19	48.5	135	406
EC250-24	68.4	129	598
EC300-19	65.4	170	462
EC300-24	94.3	160	653
EC300-30	130	155	958
EC350-19	81.3	210	494
EC350-24	117	200	700
EC350-30	167	188	985

NOTES: 1.  $Z_e$  effective section modulus at yield stress (bending). 2.  $y_c$  depth to neutral axis top fibre (bending). 3.  $A_e$  effective area at yield stress (compression).

# Design Capacity Tables

## How to Use Design Capacity Tables

The procedure for using the **Stramit Exacta® C&Z Purlins and Girts** manual is largely self-explanatory. Please ensure that you are familiar with the assumptions and conditions by reading the manual fully.

## Section Properties

The section properties in Tables 6 to 9 (previous page) are subject to slight variation due to commercial tolerances on dimensions and mathematical rounding.

## Span Configurations

**Single Spans** - a span that is simply supported by means of bolting the web of the purlin to a cleat or other rigid structure. Under these conditions bridging does not influence inward capacities, but outward capacities vary dependent on the number of rows of bridging.



**Double Spans** - are simply supported at each end and in the centre. They may comprise only one purlin over the full length or two purlins lapped together over the central support to provide continuity. Both inward and outward capacities are influenced by bridging in double spans.

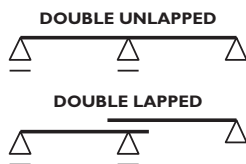

**Continuous Spans** - are simply supported at each end and at a series of equally spaced intermediate supports. These tables are for spans in which purlins are lapped over each support, where the lap length is 15% of the span.

Tables are given for 5 or more spans. For outwards loads on equal continuous spans the bridging shown is required in the end spans.

One less row of bridging can be used for internal spans if inwards capacity, Stramit's recommended minimum bridging and practical spacing requirements allow. For inwards loads the required bridging in the table applies to all spans.



**Other Span Types** - can easily be obtained using **EX-facta™** design software.

# Design Capacities

Design Capacity tables for **Stramit Exacta® C&Z Purlins and Girts**, in Limit-State Format, are as follows:

**Table**

- 10a Single Spans Outwards Design Capacity
- 10b Single Spans Inwards Design Capacity
- 11a Double Unlapped Spans Outwards Design Capacity
- 11b Double Unlapped Spans Inwards Design Capacity
- 12a Double Lapped Spans Outwards Design Capacity
- 12b Double Lapped Spans Inwards Design Capacity
- 13a 5 Lapped Spans Outwards Design Capacity
- 13b 5 Lapped Spans Inwards Design Capacity

To be read in conjunction with **Stramit® Purlins, Girts & Bridging Technical Manual**

## KEY TO TABLES

EZ150-15			
0	1	2	3
<b>10.1</b>	<b>10.1</b>	<b>10.1</b>	<b>10.1</b>
7.52	7.52	7.52	7.52
5.67	5.67	5.67	5.67
4.34	4.34	4.34	4.34
3.32	3.43	3.43	3.43
	2.78	2.78	2.78
		2.29	2.29
			1.93

Numbers in **bold italics** require bolts grade 8.8

300 and 350 series require M16 bolts

EZ150-12			
0	1	2	3
6.35	6.35	6.35	6.35
4.94	4.94	4.94	4.94
3.95	3.95	3.95	3.95
3.22	3.22	3.22	3.22
2.66	2.66	2.66	2.66
	2.16	2.16	2.16
		1.78	1.78
			1.50

“0, 1, 2, 3” are required rows of bridging

EC/EZ150-10			
0	1	2	L/150
5.04	5.04	5.04	5.04
3.61	3.61	3.61	3.55
2.65	2.65	2.65	2.24
2.03	2.03	2.03	1.50
1.60	1.60	1.60	1.05
	1.30	1.30	0.77
		1.07	0.58
			0.44

L/150 is a deflection-based serviceability limit

EZ150-15			
0	1	2	3
<b>10.1</b>	<b>10.1</b>	<b>10.1</b>	<b>10.1</b>
7.52	7.52	7.52	7.52
5.67	5.67	5.67	5.67
4.34	4.34	4.34	4.34
3.32	3.43	3.43	3.43
	2.78	2.78	2.78
		2.29	2.29
			1.93

■ Outside of Stramit’s recommended bridging requirements

■ Additional bridging does not increase capacity

Table 10a

## SINGLE SPAN – STRAMIT EXACTA® C or Z PURLINS Outwards Design Capacity (kN/m)

SPAN	EC/EZ150-10				EC/EZ150-12				EC/EZ150-15				EC/EZ150-19				EC/EZ150-24				EC/EZ200-12				SPAN
	0	1	2	3	0	1	2	3	0	1	2	3	0	1	2	3	0	1	2	3	0	1	2	3	
2500	5.04	5.04	5.04	5.04	6.38	6.38	6.38	6.38	7.98	8.21	8.21	8.21	11.0	11.4	11.4	11.4	13.9	15.6	15.6	15.6	6.41	6.41	6.41	6.41	2500
3000	3.10	3.61	3.61	3.61	3.93	4.43	4.43	4.43	4.96	5.70	5.70	5.70	6.56	7.91	7.91	7.91	8.40	10.8	10.8	10.8	5.34	5.34	5.34	5.34	3000
3500	1.83	2.65	2.65	2.65	2.31	3.26	3.26	3.26	3.06	4.19	4.19	4.19	3.96	5.81	5.81	5.81	5.17	7.95	7.95	7.95	4.12	4.58	4.58	4.58	3500
4000	1.13	2.03	2.03	2.03	1.42	2.49	2.49	2.49	1.85	3.21	3.21	3.21	2.41	4.45	4.45	4.45	3.21	5.81	6.08	6.08	2.78	3.57	3.57	3.57	4000
4500	0.73	1.58	1.60	1.60	0.92	1.97	1.97	1.97	1.18	2.46	2.53	2.53	1.56	3.39	3.52	3.52	2.10	4.31	4.81	4.81	1.84	2.82	2.82	2.82	4500
5000	1.18	1.30	1.30	1.30	0.62	1.52	1.60	1.60	0.80	1.87	2.05	2.05	1.06	2.54	2.85	2.85	1.45	3.25	3.89	3.89	1.25	2.28	2.28	2.28	5000
5500	0.89	1.07	1.07		1.13	1.32	1.32		0.56	1.45	1.70	1.70	0.76	1.91	2.35	2.35	1.04	2.47	3.17	3.22	0.89	1.82	1.89	1.89	5500
6000		0.65	0.90			0.83	1.11	1.11		1.10	1.43	1.43	0.56	1.44	1.98	1.98	0.78	1.88	2.56	2.70	0.64	1.45	1.59	1.59	6000
6500			0.77			0.62	0.94	0.94		0.82	1.19	1.22		1.07	1.65	1.69	0.60	1.43	2.09	2.30		1.15	1.35	1.35	6500
7000			0.63			0.81	0.81	0.81		0.61	0.98	1.05		0.81	1.35	1.45		1.08	1.72	1.99		0.92	1.17	1.17	7000
7500			0.52			0.66	0.71			0.82	0.91			0.62	1.11	1.27		0.84	1.42	1.71		0.73	1.01	1.02	7500
8000			0.51			0.54	0.62			0.69	0.80			0.91	1.11			0.66	1.18	1.46		0.58	0.86	0.89	8000
8500							0.55				0.58	0.71			0.75	0.99			0.53	0.98	1.25		0.74	0.79	8500
9000											0.62	0.80			0.62	0.85				0.81	1.08		0.63	0.71	9000
9500											0.54	0.70			0.51	0.74				0.67	0.94		0.54	0.63	9500
10000												0.54				0.64				0.56	0.82			0.57	10000
10500																				0.55			0.71	0.51	10500
11000																							0.62	0.51	11000
11500																							0.54	0.51	11500
12000																							0.54	0.51	12000
SPAN	EC/EZ200-15				EC/EZ200-19				EC/EZ200-24				EC/EZ250-15				EC/EZ250-19				EC/EZ250-24				SPAN
SPAN	0	1	2	3	0	1	2	3	0	1	2	3	0	1	2	3	0	1	2	3	0	1	2	3	
2500	11.9	11.9	11.9	11.9	17.3	17.3	17.3	17.3	24.0	24.0	24.0	24.0	9.91	9.91	9.91	9.91	20.2	20.2	20.2	20.2	30.8	30.8	30.8	30.8	2500
3000	8.27	8.27	8.27	8.27	11.6	12.0	12.0	12.0	15.9	16.7	16.7	16.7	8.26	8.26	8.26	8.26	15.2	15.2	15.2	15.2	21.0	21.4	21.4	21.4	3000
3500	5.50	6.08	6.08	6.08	7.77	8.83	8.83	8.83	10.3	12.2	12.3	12.2	7.08	7.08	7.08	7.08	10.1	11.2	11.2	11.2	13.8	15.7	15.7	15.7	3500
4000	3.59	4.65	4.65	4.65	5.24	6.76	6.76	6.76	6.71	9.38	9.38	9.38	4.97	6.05	6.05	6.05	6.80	8.57	8.57	8.57	8.9	12.0	12.0	12.0	4000
4500	2.38	3.68	3.68	3.68	3.36	5.34	5.34	5.34	4.35	7.41	7.41	7.41	3.32	4.78	4.78	4.78	4.44	6.77	6.77	6.77	5.70	9.49	9.49	9.49	4500
5000	1.65	2.98	2.98	2.98	2.25	4.33	4.33	4.33	2.93	6.00	6.00	6.00	2.31	3.87	3.87	3.87	2.96	5.48	5.48	5.48	3.82	7.69	7.69	7.69	5000
5500	1.15	2.46	2.46	2.46	1.57	3.42	3.58	3.58	2.06	4.72	4.96	4.96	1.60	3.14	3.20	3.20	2.05	4.53	4.53	4.53	2.66	6.20	6.35	6.35	5500
6000	0.82	1.95	2.07	2.07	1.13	2.73	3.01	3.01	1.56	3.70	4.17	4.17	1.14	2.52	2.69	2.69	1.47	3.56	3.81	3.81	1.92	4.90	5.34	5.34	6000
6500	0.61	1.53	1.76	1.76	0.84	2.20	2.56	2.56	1.12	2.91	3.55	3.55	0.84	2.04	2.29	2.29	1.09	2.85	3.24	3.24	1.43	3.89	4.55	4.55	6500
7000		1.20	1.52	1.52	0.64	1.77	2.21	2.21	0.86	2.29	3.06	3.06	0.63	1.65	1.98	1.98	0.82	2.28	2.80	2.80	1.09	3.03	3.92	3.92	7000
7500		0.94	1.32	1.32		1.38	1.92	1.92	0.67	1.79	2.65	2.67		1.33	1.72	1.72	0.64	1.81	2.44	2.44	0.85	2.35	3.42	3.42	7500
8000		0.75	1.16	1.16		1.07	1.63	1.69	0.54	1.40	2.25	2.35		1.05	1.49	1.51	0.50	1.41	2.14	2.14	0.67	1.83	2.95	3.00	8000
8500		0.62	1.00	1.03		0.85	1.39	1.50		1.11	1.90	2.08		0.85	1.28	1.34		1.11	1.83	1.90	0.54	1.45	2.51	2.66	8500
9000			0.85	0.92		0.68	1.20	1.34		0.89	1.61	1.85		0.69	1.11	1.20		0.89	1.56	1.69		1.16	2.14	2.37	9000
9500			0.72	0.83		0.55	1.04	1.20		0.73	1.37	1.66		0.56	0.96	1.07		0.72	1.34	1.52		0.94	1.83	2.13	9500
10000			0.61	0.74			0.90	1.08		0.60	1.17	1.50			0.83	0.97		0.59	1.15	1.37		0.77	1.55	1.92	10000
10500			0.52	0.68			0.77	0.97			0.99	1.34			0.72	0.88			0.99	1.24		0.64	1.31	1.74	10500
11000				0.62			0.64	0.86			0.84	1.18			0.62	0.79			0.84	1.13		0.54	1.10	1.55	11000
11500				0.55			0.54	0.77			0.71	1.05			0.53	0.70			0.71	1.01		0.92	1.38	1.82	11500
12000								0.69			0.60	0.93				0.63			0.60	0.90		0.78	1.23	1.65	12000
12500								0.62			0.51	0.83				0.57			0.51	0.80		0.67	1.10	1.48	12500
13000								0.55				0.73				0.51				0.72		0.57	0.98	1.30	13000
13500												0.65								0.64			0.87	1.18	13500
14000												0.58								0.57			0.76	1.07	14000
14500												0.51								0.51			0.67	0.99	14500
15000												0.51								0.51			0.59	0.87	15000
SPAN	EC/EZ300-19				EC/EZ300-24				EC/EZ300-30				EC/EZ350-19				EC/EZ350-24				EC/EZ350-30				SPAN
SPAN	0	1	2	3	0	1	2	3	0	1	2	3	0	1	2	3	0	1	2	3	0	1	2	3	
4000	10.4	10.4	10.4	10.4	15.9	16.4	16.4	16.4	22.3	23.2	23.2	23.2	8.87	8.87	8.87	8.87	17.9	17.9	17.9	17.9	29.4	29.4	29.4	29.4	4000
4500	8.39	9.19	9.19	9.19	11.4	13.0	13.0	13.0	16.1	18.3	18.3	18.3	7.89	7.89	7.89	7.89	15.9	15.9	15.9	15.9	23.3	23.3	23.3	23.3	4500
5000	6.28	7.45	7.45	7.45	8.33	10.5	10.5	10.5	11.4	14.8	14.8	14.8	7.10	7.10	7.10	7.10	13.3	13.5	13.5	13.5	18.1	18.8	18.8	18.8	5000
5500	4.52	6.15	6.15	6.15	6.09	8.67	8.67	8.67	8.06	12.3	12.3	12.3	6.45	6.45	6.45	6.45	10.4	11.2	11.2	11.2	13.9	15.6	15.6	15.6	5500
6000	3.32	5.17	5.17	5.17	4.37	7.29	7.29	7.29	5.78	10.3	10.3	10.3	5.78	5.92	5.92	5.92	8.31	9.41	9.41	9.41	10.8	13.1	13.1	13.1	6000
6500	2.50	4.41	4.41	4.41	3.21	6.21	6.21	6.21	4.26	8.78	8.78	8.78	4.60	5.46	5.46	5.46	6.40	8.02	8.02	8.02	8.34	11.1	11.1	11.1	6500
7000	1.88	3.75	3.80	3.80	2.42	5.31	5.36	5.36	3.22	7.43	7.57	7.57	3.64	4.88	4.88	4.88	4.93	6.91	6.91	6.91	6.56	9.61	9.61	9.61	7000
7500	1.44	3.16	3.31	3.31	1.86	4.41	4.67	4.67	2.48	6.23	6.60	6.60	2.92	4.25	4.25	4.25	3.86	6.02	6.02	6.02	5.14	8.37	8.37	8.37	7500
8000	1.13	2.68	2.91	2.91	1.46	3.67	4.10	4.10	1.95	5.21	5.80	5.80	2.32	3.74	3.74	3.74	3.07	5.29	5.29	5.29	4.01	7.36	7.36	7.36	8000
8500	0.89	2.28	2.58	2.58	1.16	3.06	3.63	3.63	1.56	4.32	5.13	5.13													





Table 11a

**DOUBLE UNLAPPED SPAN – STRAMIT EXACTA® C or Z PURLINS**  
**Outwards Design Capacity (kN/m)**

SPAN	EC/EZ150-10				EC/EZ150-12				EC/EZ150-15				EC/EZ150-19				EC/EZ150-24				EC/EZ200-12				SPAN
	0	1	2	3	0	1	2	3	0	1	2	3	0	1	2	3	0	1	2	3	0	1	2	3	
2500	3.44	3.43	3.43	3.43	5.30	5.30	5.30	5.30	8.04	8.04	8.04	8.04	11.4	11.4	11.4	11.4	15.6	15.6	15.6	15.6	4.65	4.65	4.65	4.65	2500
3000	2.70	2.70	2.70	2.70	4.06	4.06	4.06	4.06	5.70	5.70	5.70	5.70	7.91	7.91	7.91	7.91	10.8	10.8	10.8	10.8	3.73	3.73	3.73	3.73	3000
3500	2.18	2.18	2.18	2.18	3.19	3.19	3.19	3.19	4.19	4.19	4.19	4.19	5.81	5.81	5.81	5.81	7.95	7.95	7.95	7.95	3.07	3.07	3.07	3.07	3500
4000	1.80	1.80	1.80	1.80	2.49	2.49	2.49	2.49	3.21	3.21	3.21	3.21	4.45	4.45	4.45	4.45	5.96	6.08	6.08	6.08	2.57	2.57	2.57	2.57	4000
4500	1.50	1.50	1.50	1.50	1.97	1.97	1.97	1.97	2.53	2.53	2.53	2.53	3.52	3.52	3.52	3.52	4.49	4.81	4.81	4.81	2.18	2.18	2.18	2.18	4500
5000	1.27	1.27	1.27	1.27	1.60	1.60	1.60	1.60	1.99	2.05	2.05	2.05	2.72	2.85	2.85	2.85	3.45	3.89	3.89	3.89	1.88	1.88	1.88	1.88	5000
5500	1.00	1.07	1.07	1.07	1.27	1.32	1.32	1.32	1.56	1.70	1.70	1.70	2.11	2.35	2.35	2.35	2.70	3.22	3.22	3.22	1.63	1.63	1.63	1.63	5500
6000	0.78	0.90	0.90	0.90	0.99	1.11	1.11	1.11	1.25	1.43	1.43	1.43	1.66	1.98	1.98	1.98	2.13	2.69	2.70	2.70	1.42	1.42	1.42	1.42	6000
6500	0.61	0.77	0.77	0.77	0.77	0.94	0.94	0.94	1.00	1.22	1.22	1.22	1.31	1.69	1.69	1.69	1.70	2.23	2.30	2.30	1.25	1.26	1.26	1.26	6500
7000		0.66	0.66	0.66	0.59	0.81	0.81	0.81	0.79	1.05	1.05	1.05	1.03	1.45	1.45	1.45	1.36	1.86	1.99	1.99	1.03	1.11	1.11	1.11	7000
7500		0.57	0.58	0.58		0.71	0.71	0.71	0.62	0.89	0.91	0.91	0.82	1.23	1.27	1.27	1.09	1.56	1.73	1.73	0.85	0.99	0.99	0.99	7500
8000			0.51	0.51		0.61	0.62	0.62		0.75	0.80	0.80	0.65	1.03	1.11	1.11	0.88	1.32	1.52	1.52	0.70	0.89	0.89	0.89	8000
8500						0.52	0.55	0.55		0.64	0.71	0.71	0.53	0.87	0.99	0.99	0.72	1.12	1.32	1.35	0.57	0.79	0.79	0.79	8500
SPAN	EC/EZ200-15				EC/EZ200-19				EC/EZ200-24				EC/EZ250-15				EC/EZ250-19				EC/EZ250-24				SPAN
	0	1	2	3	0	1	2	3	0	1	2	3	0	1	2	3	0	1	2	3	0	1	2	3	
2500	8.27	8.27	8.27	8.27	12.6	12.6	12.6	12.6	15.9	15.9	15.9	15.9	7.28	7.28	7.28	7.28	12.6	12.6	12.6	12.6	15.9	15.9	15.9	15.9	2500
3000	6.45	6.45	6.45	6.45	10.5	10.5	10.5	10.5	13.3	13.3	13.3	13.3	5.87	5.87	5.87	5.87	10.5	10.5	10.5	10.5	13.3	13.3	13.3	13.3	3000
3500	5.16	5.16	5.16	5.16	8.64	8.64	8.64	8.64	11.4	11.4	11.4	11.4	4.85	4.85	4.85	4.85	8.79	8.79	8.79	8.79	11.4	11.4	11.4	11.4	3500
4000	4.21	4.21	4.21	4.21	6.76	6.76	6.76	6.76	9.38	9.38	9.38	9.38	4.08	4.08	4.08	4.08	7.24	7.24	7.24	7.24	10.0	10.0	10.0	10.0	4000
4500	3.50	3.50	3.50	3.50	5.34	5.34	5.34	5.34	7.41	7.41	7.41	7.41	3.48	3.48	3.48	3.48	6.05	6.05	6.05	6.05	8.85	8.85	8.85	8.85	4500
5000	2.95	2.95	2.95	2.95	4.33	4.33	4.33	4.33	6.00	6.00	6.00	6.00	3.00	3.00	3.00	3.00	5.13	5.13	5.13	5.13	7.69	7.69	7.69	7.69	5000
5500	2.46	2.46	2.46	2.46	3.56	3.58	3.58	3.58	4.90	4.96	4.96	4.96	2.61	2.61	2.61	2.61	4.40	4.40	4.40	4.40	6.35	6.35	6.35	6.35	5500
6000	2.07	2.07	2.07	2.07	2.86	3.01	3.01	3.01	3.92	4.17	4.17	4.17	2.29	2.29	2.29	2.29	3.78	3.80	3.80	3.80	5.16	5.34	5.34	5.34	6000
6500	1.69	1.76	1.76	1.76	2.34	2.56	2.56	2.56	3.16	3.55	3.55	3.55	2.03	2.03	2.03	2.03	3.05	3.24	3.24	3.24	4.17	4.55	4.55	4.55	6500
7000	1.37	1.52	1.52	1.52	1.93	2.21	2.21	2.21	2.56	3.06	3.06	3.06	1.79	1.80	1.80	1.80	2.50	2.80	2.80	2.80	3.40	3.92	3.92	3.92	7000
7500	1.11	1.32	1.32	1.32	1.61	1.92	1.92	1.92	2.08	2.67	2.67	2.67	1.49	1.61	1.61	1.61	2.05	2.44	2.44	2.44	2.75	3.42	3.42	3.42	7500
8000	0.90	1.16	1.16	1.16	1.32	1.69	1.69	1.69	1.69	2.35	2.35	2.35	1.24	1.45	1.45	1.45	1.69	2.14	2.14	2.14	2.21	3.00	3.00	3.00	8000
8500	0.74	1.03	1.03	1.03	1.06	1.49	1.50	1.50	1.38	2.06	2.08	2.08	1.02	1.31	1.31	1.31	1.38	1.90	1.90	1.90	1.78	2.66	2.66	2.66	8500
SPAN	EC/EZ300-19				EC/EZ300-24				EC/EZ300-30				EC/EZ350-19				EC/EZ350-24				EC/EZ350-30				SPAN
	0	1	2	3	0	1	2	3	0	1	2	3	0	1	2	3	0	1	2	3	0	1	2	3	
4000	7.13	7.13	7.13	7.13	12.9	12.9	12.9	12.9	21.1	21.1	21.1	21.1	6.57	6.57	6.57	6.57	12.4	12.4	12.4	12.4	22.1	22.1	22.1	22.1	4000
4500	6.12	6.12	6.12	6.12	10.8	10.8	10.8	10.8	17.5	17.5	17.5	17.5	5.73	5.73	5.73	5.74	10.7	10.7	10.7	10.7	18.7	18.7	18.7	18.7	4500
5000	5.31	5.31	5.31	5.31	9.26	9.26	9.26	9.26	14.6	14.6	14.6	14.6	5.06	5.06	5.06	5.06	9.31	9.31	9.31	9.31	16.0	16.0	16.0	16.0	5000
5500	4.66	4.66	4.66	4.66	7.98	7.98	7.98	7.98	12.3	12.3	12.3	12.3	4.50	4.50	4.50	4.50	8.18	8.18	8.18	8.18	13.9	13.9	13.9	13.9	5500
6000	4.11	4.11	4.11	4.11	6.95	6.95	6.95	6.95	10.3	10.3	10.3	10.3	4.04	4.04	4.04	4.04	7.24	7.24	7.24	7.24	12.1	12.1	12.1	12.1	6000
6500	3.65	3.65	3.65	3.65	6.09	6.09	6.09	6.09	8.78	8.78	8.78	8.78	3.64	3.64	3.64	3.64	6.45	6.45	6.45	6.45	10.7	10.7	10.7	10.7	6500
7000	3.27	3.27	3.27	3.27	5.36	5.36	5.36	5.36	7.56	7.57	7.57	7.57	3.30	3.30	3.30	3.30	5.77	5.77	5.77	5.77	9.45	9.45	9.45	9.45	7000
7500	2.93	2.93	2.94	2.93	4.60	4.67	4.67	4.67	6.41	6.60	6.60	6.60	3.01	3.01	3.01	3.01	5.20	5.20	5.20	5.20	8.37	8.37	8.37	8.37	7500
8000	2.65	2.65	2.65	2.65	3.88	4.10	4.10	4.10	5.43	5.80	5.80	5.80	2.75	2.75	2.75	2.75	4.70	4.70	4.70	4.70	7.36	7.36	7.36	7.36	8000
8500	2.40	2.40	2.40	2.40	3.28	3.63	3.63	3.63	4.61	5.13	5.13	5.13	2.52	2.52	2.52	2.52	4.27	4.27	4.27	4.27	6.52	6.52	6.52	6.52	8500

Table 11b

**DOUBLE UNLAPPED SPAN – STRAMIT EXACTA® C or Z PURLINS**  
**Inwards Design Capacity (kN/m)**

SPAN	EC/EZ150-10				EC/EZ150-12				EC/EZ150-15				EC/EZ150-19				EC/EZ150-24				EC/EZ200-12				SPAN
	0	1	2	L/150	0	1	2	L/150	0	1	2	L/150	0	1	2	L/150	0	1	2	L/150	0	1	2	L/150	
2500	3.43	3.43	3.43	14.79	5.30	5.30	5.30	18.33	8.04	8.04	8.04	23.36	<b>11.4</b>	<b>11.4</b>	<b>11.4</b>	30.0	<b>14.6</b>	<b>15.6</b>	<b>15.6</b>	38.1	4.65	4.65	4.65	38.3	2500
3000	2.70	2.70	2.70	8.56	4.06	4.06	4.06	10.61	5.70	5.70	5.70	13.52	7.91	7.91	7.91	17.3	<b>9.69</b>	<b>10.8</b>	<b>10.8</b>	22.1	3.73	3.73	3.73	22.2	3000
3500	2.18	2.18	2.18	5.39	3.19	3.19	3.19	6.68	4.19	4.19	4.19	8.51	5.66	5.81	5.81	10.9	6.86	<b>7.95</b>	<b>7.95</b>	13.9	3.07	3.07	3.07	14.0	3500
4000	1.80	1.80	1.80	3.61	2.49	2.49	2.49	4.48	3.20	3.21	3.21	5.70	4.21	4.45	4.45	7.31	5.09	<b>6.08</b>	<b>6.08</b>	9.31	2.57	2.57	2.57	9.36	4000
4500	1.50	1.50	1.50	2.54	1.97	1.97	1.97	3.14	2.48	2.53	2.53	4.01	3.24	3.52	3.52	5.14	3.90	4.81	4.81	6.54	2.18	2.18	2.18	6.57	4500
5000	1.27	1.27	1.27	1.85	1.60	1.60	1.60	2.29	1.97	2.05	2.05	2.92	2.56	2.85	2.85	3.75	3.08	3.89	3.89	4.77	1.88	1.88	1.88	4.79	5000
5500	1.07	1.07	1.07	1.39	1.32	1.32	1.32	1.72	1.60	1.70	1.70	2.19	2.07	2.35	2.35	2.81	2.48	3.22	3.22	3.58	1.63	1.63	1.63	3.60	5500
6000	0.90	0.90	0.90	1.07	1.11	1.11	1.11	1.33	1.32	1.43	1.43	1.69	1.70	1.98	1.98	2.17	2.04	2.70	2.70	2.76	1.42	1.42	1.42	2.77	6000
6500	0.77	0.77	0.77	0.84	0.94	0.94	0.94	1.04	1.11	1.22	1.22	1.33	1.41	1.69	1.69	1.71	1.70	2.30	2.30	2.17	1.26	1.26	1.26	2.18	6500
7000	0.65	0.66	0.66	0.85	0.80	0.81	0.81	0.84	0.94	1.05	1.05	1.06	1.19	1.45	1.45	1.37	1.43	1.99	1.99	1.74	1.10	1.11	1.11	1.75	7000
7500	0.55	0.58	0.58	0.55	0.68	0.71	0.71	0.68	0.81	0.91	0.91	0.87	1.01	1.27	1.27	1.11	1.22	1.72	1.73	1.41	0.95	0.99	0.99	1.42	7500
8000		0.51	0.51	0.45	0.59	0.62	0.62	0.56	0.70	0.80	0.80	0.71	0.87	1.11	1.11	0.91	1.04	1.49	1.52	1.16	0.82	0.89	0.89	1.17	8000
8500					0.51	0.55	0.55	0.47	0.61	0.71	0.71	0.59	0.75	0.99	0.99	0.76	0.90	1.30	1.35	0.97	0.72	0.79	0.79	0.98	8500
SPAN	EC/EZ200-15				EC/EZ200-19				EC/EZ200-24				EC/EZ250-15				EC/EZ250-19				EC/EZ250-24				SPAN
	0	1	2	L/150	0	1	2	L/150	0	1	2	L/150	0	1	2	L/150	0	1	2	L/150	0	1	2	L/150	
2500	8.27	8.27	8.27	49.89	<b>12.6</b>	<b>12.6</b>	<b>12.6</b>	65.9	<b>15.9</b>	<b>15.9</b>	<b>15.9</b>	84.4	7.28	7.28	7.28	84.0	<b>12.6</b>	<b>12.6</b>	<b>12.6</b>	110	<b>15.9</b>	<b>15.9</b>	<b>15.9</b>	143	2500
3000	6.45	6.45	6.45	28.87	<b>10.5</b>	<b>10.5</b>	<b>10.5</b>	38.1	<b>13.3</b>	<b>13.3</b>	<b>13.3</b>	48.9	5.87	5.87	5.87	48.6	<b>10.5</b>	<b>10.5</b>	<b>10.5</b>	63.7	<b>13.3</b>	<b>13.3</b>	<b>13.3</b>	82.6	3000
3500	5.16	5.16	5.16	18.18	<b>8.57</b>	<b>8.64</b>	<b>8.64</b>	24.0	<b>11.3</b>	<b>11.4</b>	<b>11.4</b>	30.8	4.85	4.85	4.85	30.6	<b>8.79</b>	<b>8.79</b>	<b>8.79</b>	40.1	<b>11.4</b>	<b>11.4</b>	<b>11.4</b>	52.0	3500
4000	4.21	4.21	4.21	12.18	<b>6.36</b>	<b>6.76</b>	<b>6.76</b>	16.1	<b>8.26</b>	<b>9.38</b>	<b>9.38</b>	20.6	4.08	4.08	4.08	20.5	<b>7.24</b>	<b>7.24</b>	<b>7.24</b>	26.9	<b>10.0</b>	<b>10.0</b>	<b>10.0</b>	34.8	4000
4500	3.50	3.50	3.50	8.55	4.91	5.34	5.34	11.3	<b>6.25</b>	<b>7.41</b>	<b>7.41</b>	14.5	3.48	3.48	3.48	14.4	<b>6.05</b>	<b>6.05</b>	<b>6.05</b>	18.9	<b>8.08</b>	<b>8.85</b>	<b>8.85</b>	24.5	4500
5000	2.95	2.95	2.95	6.24	3.89	4.33	4.33	8.24	<b>4.87</b>	<b>6.00</b>	<b>6.00</b>	10.6	3.00	3.00	3.00	10.5	<b>4.95</b>	<b>5.13</b>	<b>5.13</b>	13.7	<b>6.24</b>	<b>7.69</b>	<b>7.69</b>	17.8	5000
5500	2.42	2.46	2.46	4.69	3.16	3.58	3.58	6.19	3.88	<b>4.96</b>	<b>4.96</b>	7.93	2.61	2.61	2.61	7.89	3.99	<b>4.40</b>	4.40	10.3	<b>4.94</b>	<b>6.35</b>	<b>6.35</b>	13.4	5500
6000	1.99	2.07	2.07	3.61	2.60	3.01	3.01	4.77	3.16	<b>4.17</b>	<b>4.17</b>	6.11	2.29	2.29	2.29	6.08	3.28	3.80	3.80	7.96	3.98	<b>5.34</b>	<b>5.34</b>	10.3	6000
6500	1.67	1.76	1.76	2.84	2.18	2.56	2.56	3.75	2.60	3.55	3.55	4.81	2.03	2.03	2.03	4.78	2.73	3.24	3.24	6.26	3.26	<b>4.55</b>	<b>4.55</b>	8.12	6500
7000	1.41	1.52	1.52	2.27	1.85	2.21	2.21	3.00	2.18	3.06	3.06	3.85	1.78	1.80	1.80	3.83	2.30	2.80	2.80	5.01	2.71	<b>3.92</b>	<b>3.92</b>	6.50	7000
7500	1.20	1.32	1.32	1.85	1.58	1.92	1.92	2.44	1.84	2.67	2.67	3.13	1.52	1.61	1.61	3.11	1.96	2.44	2.44	4.07	2.27	<b>3.42</b>	<b>3.42</b>	5.28	7500
8000	1.04	1.16	1.16	1.52	1.36	1.69	1.69	2.01	1.57	2.35	2.35	2.58	1.32	1.45	1.45	2.57	1.69	2.14	2.14	3.36	1.93	3.00	3.00	4.35	8000
8500	0.90	1.03	1.03	1.27	1.17	1.50	1.50	1.68	1.35	2.08	2.08	2.15	1.15	1.31	1.31	2.14	1.46	1.90	1.90	2.80	1.66	2.66	2.66	3.63	8500
SPAN	EC/EZ300-19				EC/EZ300-24				EC/EZ300-30				EC/EZ350-19				EC/EZ350-24				EC/EZ350-30				SPAN
	0	1	2	L/150	0	1	2	L/150	0	1	2	L/150	0	1	2	L/150	0	1	2	L/150	0	1	2	L/150	
4000	7.13	7.13	7.13	47.1	<b>12.9</b>	<b>12.9</b>	<b>12.9</b>	61.5	<b>21.0</b>	<b>21.1</b>	<b>21.1</b>	79.4	6.57	6.57	6.57	76.6	<b>12.4</b>	<b>12.4</b>	<b>12.4</b>	99.8	<b>22.1</b>	<b>22.1</b>	<b>22.1</b>	129	4000
4500	6.12	6.12	6.12	33.0	<b>10.8</b>	<b>10.8</b>	<b>10.8</b>	43.2	<b>15.4</b>	<b>17.5</b>	<b>17.5</b>	55.8	5.73	5.73	5.73	53.8	<b>10.7</b>	<b>10.7</b>	<b>10.7</b>	70.1	<b>18.7</b>	<b>18.7</b>	<b>18.7</b>	90.7	4500
5000	5.31	5.31	5.31	24.1	8.91	<b>9.26</b>	<b>9.26</b>	31.5	<b>11.6</b>	<b>14.6</b>	<b>14.6</b>	40.7	5.06	5.06	5.06	39.2	<b>9.31</b>	<b>9.31</b>	<b>9.31</b>	51.1	<b>16.0</b>	<b>16.0</b>	<b>16.0</b>	66.1	5000
5500	4.66	4.66	4.66	18.1	7.07	7.98	7.98	23.6	<b>8.93</b>	<b>12.3</b>	<b>12.3</b>	30.6	4.50	4.50	4.50	29.5	8.18	8.18	8.18	38.4	<b>12.7</b>	<b>13.9</b>	<b>13.9</b>	49.7	5500
6000	4.11	4.11	4.11	13.9	5.72	6.95	6.95	18.2	7.00	<b>10.3</b>	<b>10.3</b>	23.5	4.04	4.04	4.04	22.7	7.24	7.24	7.24	29.6	<b>10.0</b>	<b>12.1</b>	<b>12.1</b>	38.3	6000
6500	3.65	3.65	3.65	11.0	4.70	6.09	6.09	14.3	5.60	<b>8.78</b>	<b>8.78</b>	18.5	3.64	3.64	3.64	17.9	6.45	6.45	6.45	23.3	<b>8.11</b>	<b>10.7</b>	<b>10.7</b>	30.1	6500
7000	3.22	3.27	3.27	8.78	3.92	5.36	5.36	11.5	4.57	<b>7.57</b>	<b>7.57</b>	14.8	3.30	3.30	3.30	14.3	5.43	5.77	5.77	18.6	<b>6.65</b>	<b>9.45</b>	<b>9.45</b>	24.1	7000
7500	2.74	2.93	2.94	7.14	3.29	4.67	4.67	9.33	3.80	<b>6.60</b>	<b>6.60</b>	12.0	3.01	3.01	3.01	11.6	4.51	5.20	5.20	15.1	5.52	<b>8.37</b>	<b>8.37</b>	19.6	7500
8000	2.34	2.65	2.65	5.88	2.79	4.10	4.10	7.68	3.20	<b>5.80</b>	<b>5.80</b>	9.93	2.75	2.75	2.75	9.58	3.79	4.70	4.70	12.5	4.63	<b>7.36</b>	<b>7.36</b>	16.1	8000
8500	2.01	2.40	2.40	4.90	2.39	3.63	3.63	6.41	2.73	5.13	5.13	8.28	2.52	2.52	2.52	7.98	3.23	4.27	4.27	10.4	3.92	<b>6.52</b>	<b>6.52</b>	13.5	8500





Table I2b

## DOUBLE LAPPED SPAN – STRAMIT EXACTA® Z-PURLINS Inwards Design Capacity (kN/m)

SPAN	EZ150-10				EZ150-12				EZ150-15				EZ150-19				EZ150-24				EZ200-12				SPAN
	0	1	2	L/ISO	0	1	2	L/ISO	0	1	2	L/ISO	0	1	2	L/ISO	0	1	2	L/ISO	0	1	2	L/ISO	
2500	4.00	4.00	4.00	16.76	6.35	6.35	6.35	20.8	10.1	10.1	10.1	26.5	14.7	15.4	15.4	33.9	18.0	19.7	19.7	43.2	5.32	5.32	5.32	43.4	2500
3000	3.19	3.19	3.19	9.70	4.94	4.94	4.94	12.02	7.45	7.52	7.52	15.3	9.71	10.7	10.7	19.6	11.7	14.6	14.6	25.0	4.32	4.32	4.31	25.1	3000
3500	2.61	2.61	2.61	6.11	3.95	3.95	3.95	7.57	5.31	5.67	5.67	9.64	6.82	7.86	7.86	12.4	8.15	10.7	10.7	15.7	3.59	3.59	3.59	15.8	3500
4000	2.18	2.18	2.18	4.09	3.22	3.22	3.22	5.07	3.97	4.34	4.34	6.46	5.01	6.02	6.02	8.29	5.95	8.23	8.23	10.6	3.04	3.04	3.04	10.6	4000
4500	1.84	1.84	1.84	2.87	2.64	2.66	2.66	3.56	3.07	3.43	3.43	4.54	3.82	4.76	4.76	5.82	4.51	6.50	6.50	7.41	2.61	2.61	2.61	7.45	4500
5000	1.58	1.58	1.58	2.10	2.09	2.16	2.16	2.60	2.44	2.78	2.78	3.31	2.99	3.85	3.85	4.24	3.52	5.27	5.27	5.40	2.26	2.26	2.26	5.43	5000
5500	1.36	1.36	1.36	1.57	1.69	1.78	1.78	1.95	1.98	2.29	2.29	2.49	2.39	3.18	3.18	3.19	2.80	4.35	4.35	4.06	1.98	1.98	1.98	4.08	5500
6000	1.14	1.19	1.19	1.21	1.38	1.50	1.50	1.50	1.63	1.93	1.93	1.91	1.94	2.68	2.68	2.46	2.28	3.62	3.66	3.13	1.75	1.75	1.75	3.14	6000
6500	0.95	1.04	1.04	0.95	1.14	1.28	1.28	1.18	1.36	1.64	1.64	1.51	1.60	2.28	2.28	1.93	1.88	3.03	3.12	2.46	1.55	1.55	1.55	2.47	6500
7000	0.79	0.90	0.90	0.76	0.96	1.10	1.10	0.95	1.14	1.42	1.42	1.21	1.33	1.97	1.97	1.55	1.57	2.57	2.69	1.97	1.35	1.39	1.39	1.98	7000
7500	0.67	0.78	0.78	0.62	0.80	0.96	0.96	0.77	0.96	1.23	1.23	0.98	1.12	1.71	1.71	1.26	1.32	2.20	2.34	1.60	1.15	1.25	1.25	1.61	7500
8000	0.58	0.69	0.69	0.51	0.68	0.84	0.84	0.63	0.82	1.08	1.08	0.81	0.95	1.51	1.51	1.04	1.13	1.90	2.06	1.32	0.99	1.13	1.13	1.33	8000
8500		0.61	0.61	0.43	0.58	0.75	0.75	0.53	0.70	0.96	0.96	0.67	0.81	1.33	1.33	0.86	0.97	1.66	1.82	1.10	0.86	1.02	1.02	1.11	8500
9000		0.54	0.54	0.36	0.50	0.67	0.67	0.45	0.60	0.86	0.86	0.57	0.70	1.17	1.19	0.73	0.84	1.45	1.60	0.93	0.75	0.93	0.93	1.11	9000
9500						0.60	0.60	0.38	0.52	0.76	0.77	0.48	0.61	1.03	1.07	0.62	0.74	1.28	1.41	0.79	0.66	0.85	0.85	0.79	9500
10000						0.54	0.54	0.33		0.67	0.69	0.41	0.53	0.91	0.96	0.53	0.65	1.13	1.25	0.68	0.58	0.77	0.77	0.68	10000
10500										0.60	0.63	0.36	0.47	0.81	0.87	0.46	0.57	1.01	1.12	0.58	0.51	0.70	0.70	0.59	10500
11000										0.54	0.57	0.31		0.72	0.79	0.40	0.51	0.90	1.00	0.51	0.64	0.64	0.51	0.45	11000
11500											0.52	0.27		0.64	0.71	0.35		0.80	0.90	0.44	0.58	0.58	0.45		11500
12000												0.31		0.57	0.64	0.31		0.72	0.81	0.39	0.52	0.54	0.39		12000
SPAN	EZ200-15				EZ200-19				EZ200-24				EZ250-15				EZ250-19				EZ250-24				SPAN
	0	1	2	L/ISO	0	1	2	L/ISO	0	1	2	L/ISO	0	1	2	L/ISO	0	1	2	L/ISO	0	1	2	L/ISO	
2500	9.71	9.71	9.71	56.5	17.8	17.8	17.8	74.6	19.7	19.7	19.7	95.7	8.30	8.30	8.30	95.2	16.1	16.1	16.1	125	19.7	19.7	19.7	162	2500
3000	7.69	7.69	7.69	32.7	13.7	13.7	13.7	43.2	16.4	16.4	16.4	55.4	6.75	6.75	6.75	55.1	12.8	12.8	12.8	72.1	16.4	16.4	16.4	93.5	3000
3500	6.24	6.24	6.24	20.6	10.6	10.8	10.8	27.2	13.2	14.1	14.1	34.9	5.64	5.63	5.64	34.7	10.5	10.5	10.5	45.4	14.1	14.1	14.1	58.9	3500
4000	5.17	5.17	5.17	13.8	7.81	8.74	8.74	18.2	9.41	12.3	12.3	23.4	4.79	4.79	4.79	23.2	8.77	8.77	8.77	30.4	11.9	12.3	12.3	39.5	4000
4500	4.34	4.34	4.34	9.69	5.97	7.20	7.20	12.8	6.96	10.0	10.0	16.4	4.12	4.12	4.12	16.3	7.41	7.42	7.42	21.4	8.66	10.9	10.9	27.7	4500
5000	3.57	3.69	3.69	7.06	4.64	5.85	5.85	9.33	5.31	8.12	8.12	12.0	3.59	3.59	3.59	11.9	5.77	6.35	6.35	15.6	6.55	9.85	9.85	20.2	5000
5500	2.87	3.17	3.17	5.31	3.67	4.84	4.84	7.01	4.15	6.71	6.71	8.98	3.16	3.16	3.16	8.94	4.56	5.49	5.49	11.7	5.11	8.59	8.59	15.2	5500
6000	2.34	2.75	2.75	4.09	2.95	4.06	4.06	5.40	3.33	5.64	5.64	6.92	2.79	2.79	2.79	6.89	3.68	4.79	4.79	9.01	4.09	7.22	7.22	11.7	6000
6500	1.94	2.38	2.38	3.22	2.42	3.46	3.46	4.25	2.72	4.80	4.80	5.44	2.49	2.49	2.49	5.42	3.01	4.21	4.21	7.09	3.34	6.15	6.15	9.20	6500
7000	1.63	2.06	2.06	2.57	2.01	2.99	2.99	3.40	2.27	4.14	4.14	4.36	2.12	2.23	2.23	4.34	2.50	3.73	3.73	5.68	2.78	5.31	5.31	7.36	7000
7500	1.38	1.79	1.79	2.09	1.69	2.60	2.60	2.77	1.91	3.61	3.61	3.54	1.79	2.01	2.01	3.53	2.10	3.30	3.30	4.62	2.34	4.62	4.62	5.99	7500
8000	1.18	1.57	1.57	1.73	1.43	2.29	2.29	2.28	1.63	3.17	3.17	2.92	1.53	1.82	1.82	2.91	1.78	2.90	2.90	3.80	1.94	4.06	4.06	4.93	8000
8500	1.01	1.39	1.39	1.44	1.23	2.03	2.03	1.90	1.40	2.79	2.81	2.43	1.32	1.65	1.65	2.42	1.53	2.57	2.57	3.17	1.72	3.60	3.60	4.11	8500
9000	0.88	1.24	1.24	1.21	1.07	1.81	1.81	1.60	1.22	2.46	2.51	2.05	1.14	1.51	1.51	2.04	1.33	2.29	2.29	2.67	1.49	3.17	3.21	3.46	9000
9500	0.77	1.12	1.12	1.03	0.93	1.61	1.62	1.36	1.07	2.17	2.25	1.74	1.00	1.38	1.38	1.74	1.16	2.05	2.05	2.27	1.30	2.80	2.88	2.95	9500
10000	0.67	1.01	1.01	0.88	0.81	1.43	1.46	1.17	0.94	1.92	2.03	1.50	0.88	1.27	1.27	1.49	1.01	1.85	1.85	1.95	1.15	2.49	2.60	2.53	10000
10500	0.60	0.91	0.91	0.76	0.72	1.28	1.33	1.01	0.83	1.71	1.84	1.29	0.78	1.17	1.17	1.29	0.89	1.67	1.68	1.68	1.01	2.21	2.36	2.18	10500
11000	0.53	0.83	0.83	0.66	0.64	1.15	1.21	0.88	0.74	1.53	1.68	1.12	0.69	1.07	1.08	1.12	0.79	1.50	1.53	1.46	0.90	1.98	2.15	1.90	11000
11500	0.48	0.76	0.76	0.58	0.57	1.03	1.11	0.77	0.66	1.37	1.53	0.98	0.62	0.97	0.99	0.98	0.71	1.34	1.40	1.28	0.81	1.78	1.97	1.66	11500
12000		0.70	0.70	0.51	0.51	0.94	1.02	0.68	0.60	1.23	1.41	0.87	0.56	0.88	0.91	0.86	0.63	1.21	1.29	1.13	0.73	1.61	1.81	1.46	12000
12500		0.63	0.64	0.45	0.46	0.85	0.94	0.60	0.54	1.11	1.28	0.77	0.50	0.80	0.84	0.76	0.57	1.10	1.19	1.00	0.65	1.45	1.66	1.29	12500
13000		0.57	0.60	0.40		0.78	0.85	0.53	0.49	1.01	1.17	0.68		0.73	0.78	0.68	0.51	1.00	1.10	0.89	0.59	1.31	1.51	1.15	13000
13500			0.55	0.36		0.71	0.78	0.47	0.44	0.91	1.06	0.61		0.66	0.71	0.61	0.46	0.91	1.02	0.79	0.54	1.19	1.38	1.03	13500
14000			0.51	0.32		0.65	0.71	0.43		0.83	0.97	0.55		0.61	0.66	0.54		0.83	0.93	0.71	0.49	1.08	1.26	0.92	14000
14500						0.59	0.65	0.38		0.75	0.88	0.49		0.56	0.60	0.49		0.76	0.85	0.64	0.45	0.97	1.15	0.83	14500
15000						0.55	0.60	0.35		0.69	0.81	0.44			0.56	0.44		0.69	0.78	0.58	0.88	1.06	1.06	0.75	15000
SPAN	EZ300-19				EZ300-24				EZ300-30				EZ350-19				EZ350-24				EZ350-30				SPAN
	0	1	2	L/ISO	0	1	2	L/ISO	0	1	2	L/ISO	0	1	2	L/ISO	0	1	2	L/ISO	0	1	2	L/ISO	
4000	8.29	8.29	8.29	53.3	15.4	15.4	15.4	69.6	23.3	23.3	23.3	90.0	7.48	7.48	7.48	86.8	14.4	14.4	14.4	113	23.3	23.3	23.3	146	4000
4500	7.18	7.18	7.18	37.4	13.1	13.1	13.1	48.9	16.6	20.7	20.7	63.2	6.56	6.56	6.56	61.0	12.5	12.5	12.5	79.4	20.7	20.7	20.7	103	4500
5000	6.29	6.29	6.29	27.3	10.1	11.3	11.3	35.7	12.1	18.5	18.5	46.1	5.82	5.82	5.82	44.4	11.0	11.0	11.0	57.9	18.5	18.5	18.5	74.9	5000
5500	5.56	5.56	5.56	20.5	7.76	9.84	9.84	26.8	9.12																

Table 13a

## 5 LAPPED SPANS – STRAMIT EXACTA® Z-PURLINS Outwards Design Capacity (kN/m)

SPAN	EZ150-10				EZ150-12				EZ150-15				EZ150-19				EZ150-24				EZ200-12				SPAN
	0	1	2	3	0	1	2	3	0	1	2	3	0	1	2	3	0	1	2	3	0	1	2	3	
2500	4.32	4.32	4.32	4.32	7.03	7.03	7.03	7.03	11.7	11.7	11.7	11.7	18.4	18.4	18.4	18.4	21.9	21.9	21.9	21.9	5.66	5.66	5.66	5.66	2500
3000	3.50	3.50	3.49	3.49	5.58	5.58	5.57	5.57	8.93	8.93	8.92	8.91	12.8	12.8	12.8	12.8	17.2	17.4	17.4	17.4	4.64	4.64	4.63	4.63	3000
3500	2.90	2.90	2.90	2.90	4.53	4.53	4.53	4.53	6.75	6.75	6.75	6.75	9.34	9.37	9.37	9.37	11.8	12.8	12.8	12.8	3.89	3.89	3.89	3.89	3500
4000	2.45	2.45	2.45	2.45	3.75	3.75	3.75	3.75	4.83	5.17	5.17	5.17	6.57	7.18	7.18	7.18	8.33	9.81	9.81	9.81	3.33	3.33	3.33	3.33	4000
4500	2.09	2.09	2.09	2.09	2.83	3.15	3.15	3.15	3.56	4.08	4.08	4.08	4.69	5.67	5.67	5.67	5.99	7.75	7.75	7.75	2.88	2.88	2.88	2.88	4500
5000	1.58	1.81	1.81	1.81	2.00	2.57	2.57	2.57	2.61	3.31	3.31	3.31	3.37	4.59	4.59	4.59	4.34	6.03	6.28	6.28	2.53	2.53	2.53	2.53	5000
5500	1.13	1.58	1.58	1.58	1.42	2.13	2.13	2.13	1.87	2.71	2.73	2.73	2.41	3.74	3.79	3.79	3.15	4.75	5.19	5.19	2.23	2.23	2.23	2.23	5500
6000	0.83	1.39	1.39	1.39	1.04	1.78	1.79	1.79	1.35	2.17	2.30	2.30	1.75	2.97	3.19	3.19	2.31	3.78	4.36	4.36	1.99	1.99	1.99	1.99	6000
6500	0.62	1.11	1.23	1.23	0.78	1.42	1.52	1.52	1.00	1.76	1.96	1.96	1.30	2.37	2.72	2.72	1.73	3.03	3.70	3.71	1.53	1.78	1.78	1.78	6500
7000	0.89	1.07	1.07	1.07	0.59	1.13	1.31	1.31	0.76	1.44	1.69	1.69	1.00	1.90	2.34	2.34	1.34	2.45	3.09	3.20	1.18	1.61	1.61	1.61	7000
7500	0.70	0.93	0.93	0.93	0.89	1.14	1.14	1.14	0.59	1.17	1.47	1.47	0.78	1.52	2.04	2.04	1.05	1.98	2.61	2.79	0.92	1.45	1.45	1.45	7500
8000	0.55	0.81	0.82	0.82	0.70	1.01	1.01	1.01	0.93	1.26	1.29	1.29	0.62	1.21	1.74	1.79	0.84	1.60	2.21	2.45	0.73	1.26	1.32	1.32	8000
8500	0.69	0.72	0.72	0.72	0.56	0.89	0.89	0.89	0.74	1.08	1.15	1.15	0.97	1.48	1.59	1.59	0.69	1.29	1.89	2.14	0.58	1.06	1.21	1.21	8500
9000	0.59	0.65	0.65	0.65	0.75	0.79	0.79	0.79	0.59	0.93	1.02	1.02	0.78	1.26	1.42	1.42	0.57	1.04	1.61	1.86	0.89	1.11	1.11	1.11	9000
9500	0.50	0.58	0.58	0.58	0.64	0.71	0.71	0.71	0.81	0.92	0.92	0.92	0.63	1.08	1.27	1.27	0.86	1.38	1.63	1.63	0.74	1.00	1.02	1.02	9500
10000	0.52	0.52	0.52	0.52	0.54	0.64	0.64	0.64	0.70	0.82	0.82	0.82	0.52	0.92	1.13	1.13	0.71	1.19	1.43	1.43	0.62	0.88	0.92	0.92	10000
10500	0.58	0.58	0.58	0.58	0.58	0.68	0.68	0.68	0.60	0.72	0.72	0.72	0.78	0.99	0.99	0.99	0.59	1.02	1.26	1.26	0.52	0.77	0.84	0.84	10500
11000	0.52	0.52	0.52	0.52	0.52	0.64	0.64	0.64	0.51	0.64	0.64	0.64	0.67	0.87	0.87	0.87	0.50	0.88	1.11	1.11	0.68	0.76	0.76	0.76	11000
11500	0.57	0.57	0.57	0.57	0.57	0.68	0.68	0.68	0.57	0.68	0.68	0.68	0.67	0.77	0.77	0.77	0.75	0.98	1.08	1.08	0.60	0.70	0.70	0.70	11500
12000	0.51	0.51	0.51	0.51	0.51	0.64	0.64	0.64	0.51	0.64	0.64	0.64	0.51	0.68	0.87	0.87	0.65	0.87	1.08	1.08	0.53	0.63	0.63	0.63	12000
SPAN	EZ200-15				EZ200-19				EZ200-24				EZ250-15				EZ250-19				EZ250-24				SPAN
	0	1	2	3	0	1	2	3	0	1	2	3	0	1	2	3	0	1	2	3	0	1	2	3	
2500	10.6	10.6	10.6	10.6	19.9	19.9	19.9	19.9	21.9	21.9	21.9	21.9	8.81	8.81	8.81	8.81	17.3	17.3	17.3	17.3	21.9	21.9	21.9	21.9	2500
3000	8.51	8.50	8.50	8.50	15.6	15.6	15.6	15.6	18.3	18.3	18.3	18.3	7.24	7.24	7.22	7.22	14.1	14.1	14.0	14.0	18.3	18.3	18.3	18.3	3000
3500	7.00	7.00	7.00	7.00	12.6	12.6	12.6	12.6	15.7	15.7	15.7	15.7	6.08	6.08	6.08	6.08	11.6	11.6	11.6	11.6	15.7	15.7	15.7	15.7	3500
4000	5.87	5.87	5.87	5.87	10.3	10.3	10.3	10.3	13.7	13.7	13.7	13.7	5.22	5.22	5.22	5.22	9.84	9.84	9.84	9.84	13.7	13.7	13.7	13.7	4000
4500	4.99	4.99	4.99	4.99	8.27	8.60	8.60	8.60	11.3	11.9	11.9	11.9	4.53	4.53	4.53	4.53	8.42	8.42	8.42	8.42	12.2	12.2	12.2	12.2	4500
5000	4.30	4.29	4.30	4.29	6.31	6.98	6.98	6.98	8.47	9.68	9.68	9.68	3.99	3.98	3.98	3.98	7.29	7.29	7.29	7.29	11.0	11.0	11.0	11.0	5000
5500	3.43	3.73	3.73	3.73	4.90	5.76	5.76	5.76	6.36	8.00	8.00	7.99	3.53	3.53	3.53	3.53	6.33	6.37	6.37	6.37	8.53	10.0	10.0	10.0	5500
6000	2.59	3.27	3.27	3.27	3.75	4.85	4.85	4.85	4.78	6.72	6.72	6.72	3.16	3.15	3.16	3.16	4.87	5.61	5.61	5.61	6.35	8.61	8.61	8.61	6000
6500	1.96	2.84	2.84	2.84	2.79	4.10	4.13	4.13	3.58	5.66	5.72	5.72	2.75	2.84	2.84	2.84	3.69	4.98	4.98	4.98	4.71	7.33	7.33	7.33	6500
7000	1.53	2.45	2.45	2.45	2.11	3.40	3.56	3.56	2.71	4.67	4.94	4.94	2.11	2.56	2.56	2.56	2.78	4.44	4.44	4.44	3.56	6.14	6.33	6.33	7000
7500	1.20	2.04	2.13	2.13	1.63	2.84	3.10	3.10	2.10	3.86	4.30	4.30	1.68	2.32	2.32	2.32	2.14	3.72	3.93	3.93	2.74	5.10	5.51	5.51	7500
8000	0.94	1.69	1.88	1.88	1.28	2.40	2.73	2.73	1.66	3.19	3.78	3.78	1.31	2.12	2.12	2.12	1.68	3.11	3.45	3.45	2.16	4.25	4.84	4.84	8000
8500	0.75	1.40	1.66	1.66	1.02	2.03	2.41	2.41	1.33	2.65	3.35	3.35	1.04	1.88	1.94	1.94	1.33	2.61	3.06	3.06	1.72	3.53	4.29	4.29	8500
9000	0.60	1.16	1.48	1.48	0.83	1.70	2.15	2.15	1.08	2.19	2.99	2.99	0.84	1.60	1.78	1.78	1.08	2.19	2.73	2.73	1.39	2.90	3.83	3.83	9000
9500	0.96	1.33	1.33	1.33	0.68	1.40	1.89	1.93	0.89	1.81	2.61	2.68	0.68	1.34	1.64	1.64	0.88	1.83	2.45	2.45	1.14	2.37	3.42	3.43	9500
10000	0.80	1.20	1.20	1.20	0.56	1.14	1.66	1.75	0.74	1.49	2.28	2.42	0.56	1.12	1.51	1.51	0.72	1.51	2.19	2.21	0.95	1.95	2.99	3.10	10000
10500	0.68	1.05	1.09	1.09	0.95	1.46	1.58	1.58	0.63	1.24	1.99	2.19	0.94	1.35	1.40	1.40	0.60	1.25	1.91	2.00	0.79	1.61	2.62	2.81	10500
11000	0.58	0.92	0.99	0.99	0.79	1.29	1.44	1.44	0.53	1.04	1.74	2.00	0.80	1.19	1.29	1.29	0.51	1.04	1.68	1.83	0.67	1.35	2.31	2.56	11000
11500	0.80	0.91	0.91	0.91	0.67	1.15	1.32	1.32	0.88	1.52	1.83	1.83	0.68	1.06	1.18	1.18	0.88	1.48	1.67	1.67	0.57	1.14	2.03	2.34	11500
12000	0.70	0.83	0.83	0.83	0.57	1.02	1.19	1.19	0.75	1.33	1.65	1.65	0.58	0.94	1.08	1.08	0.74	1.31	1.53	1.53	0.97	1.77	2.15	2.15	12000
12500	0.61	0.77	0.77	0.77	0.61	1.07	1.07	1.07	0.64	1.17	1.48	1.48	0.84	0.98	0.98	0.98	0.63	1.16	1.41	1.41	0.83	1.54	1.94	1.94	12500
13000	0.54	0.70	0.70	0.70	0.54	0.97	0.97	0.97	0.55	1.02	1.33	1.33	0.75	0.89	0.89	0.89	0.55	1.02	1.27	1.27	0.71	1.34	1.75	1.75	13000
13500	0.63	0.63	0.63	0.63	0.68	0.88	0.88	0.88	0.89	1.19	1.19	1.19	0.66	0.81	0.81	0.81	0.90	1.15	1.15	1.15	0.62	1.16	1.58	1.58	13500
14000	0.57	0.57	0.57	0.57	0.59	0.80	0.80	0.80	0.77	1.07	1.07	1.07	0.58	0.74	0.74	0.74	0.78	1.04	1.04	1.04	0.54	1.01	1.42	1.42	14000
14500	0.51	0.51	0.51	0.51	0.52	0.73	0.73	0.73	0.68	0.97	0.97	0.97	0.51	0.67	0.67	0.67	0.68	0.94	0.94	0.94	0.68	0.88	1.29	1.29	14500
15000	0.66	0.66	0.66	0.66	0.66	0.88	0.88	0.88	0.66	0.88	1.12	1.12	0.61	0.88	1.08	1.08	0.60	0.85	1.08	1.08	0.77	1.16	1.16	1.16	15000
SPAN	EZ300-19				EZ300-24				EZ300-30				EZ350-19				EZ350-24				EZ350-30				SPAN
	0	1	2	3	0	1	2	3	0	1	2	3	0	1	2	3	0	1	2	3	0	1	2	3	
4000	8.96	8.96	8.96	8.96	17.0	17.0	17.0	17.0	30.0	30.0	30.0	30.0	7.94	7.94	7.94	7.94	15.5	15.5	15.5	15.5	30.0	30.0	30.0	30.0	4000
4500	7.82	7.82	7.82	7.82	14.7	14.7	14.7	14.7	23.0	23.0	23.0	23.0													

Table I3b

5 LAPPED SPANS – STRAMIT EXACTA® Z-PURLINS  
Inwards Design Capacity (kN/m)

Table with columns for SPAN, EZ150-10, EZ150-12, EZ150-15, EZ150-19, EZ150-24, EZ200-12, and SPAN, and rows for spans from 2500 to 15000 mm.

## Design Member Moment Capacities

### How to use Member Moment Capacities

FOR NORMAL PURLIN APPLICATIONS (no axial loads)

1. Establish the required loads using ASI 170.
2. For each complete purlin run generate bending moment and shear force diagrams for a nominal section using an appropriate structural analysis package. (Note that lapped purlins form part of a complete purlin run).
3. Break up the entire purlin run into 'segments' which are defined as lengths between any of the following - supports, bridging and points of contraflexure (see Segments for more detail).
4. Using the appropriate Table (15-18) note the smallest section size for each segment which has adequate moment capacity. Within any segment containing a lap (usually Type 3) check for the combined purlins at the support, and for single purlin thickness at the end of the lap where the moment will be lower.
5. Re-generate the bending moment diagram using the required purlin size/thickness (in lieu of a nominal section), lap lengths and bridging positions to check that the capacities are still adequate.

Note that any changes in purlin thickness or lap lengths will alter the moment distribution and may increase moments in adjacent spans.

6. Check bolt capacities at supports using Table 4.
7. Check combined bending and shear using the formula from clause 3.3.5 of AS4600 which is;

$$\left(\frac{M^*}{\phi_b M_s}\right)^2 + \left(\frac{V^*}{\phi_v V_v}\right)^2 \leq 1.0$$

(where values of  $\phi_b M_s$  and  $\phi_v V_v$  can be obtained from Table 14).

Note that it is particularly important to check for combined bending and shear at the ends of laps where the section reverts to a single thickness.

8. Check deflection using your structural analysis package. Note that it is common practice to use a deflection limit of span/150 for purlins. More lenient limits may necessitate consideration of out-of-plane deflection caused by section asymmetry and roof slope.

See page 22 for a worked design example.

### FOR APPLICATIONS WITH COMBINED BENDING AND AXIAL LOAD

As above, except:

4. Using the appropriate Table (15-18) note the  $\phi_b M_b$  value for the preferred section size for each segment. Then check for combined bending and axial loading using the simplified formula

$$\frac{N^*}{\phi_c N_c} + \frac{M^*}{\phi_b M_b} \leq 1.0$$

(where values for  $\phi_c N_c$  can be obtained from Tables 19-22).

Within any segment containing a lap (usually Type 3) check for the combined purlins at the support, and for single purlin thickness at the end of the lap where the moment will be lower.

This simplification of clause 3.5.1 of AS/NZS 4600 is only valid for cases where

$$\frac{N^*}{\phi_c N_c} \leq 0.15$$

and for cases where all loads are in a plane of the web (data is also valid for pure axial case).

Note that axial data provided is based on the assumption of simple spans.

See page 28 for a worked design example

### Segments

In order to use the tabulated data for the Member Moment Capacity method it is necessary to break up the entire purlin run into 'segments.' Segments are defined as lengths between any of the following - supports, bridging or points of contraflexure. This results in each segment being defined as one of the following four types:

Type 1: Zero to positive moment

Type 2: Positive to positive moment

Type 3: Negative to zero moment

Type 4: Zero to zero moment

See diagrams at top of page 19.



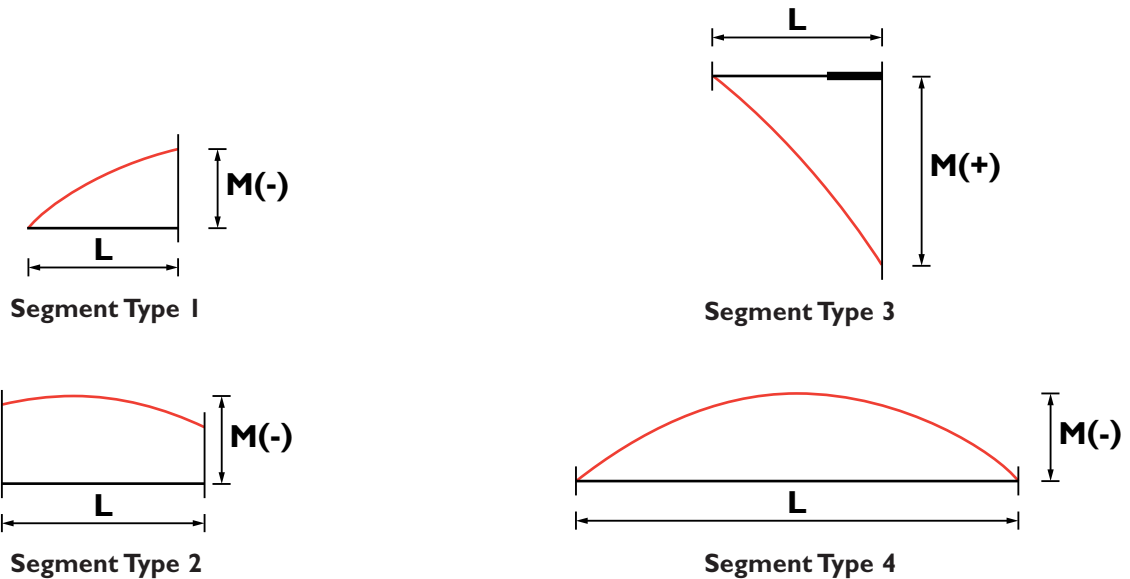

**Basic Moment Segment Types – outward cases shown**

All moment signs (+, -) are reversed for inwards loading case.

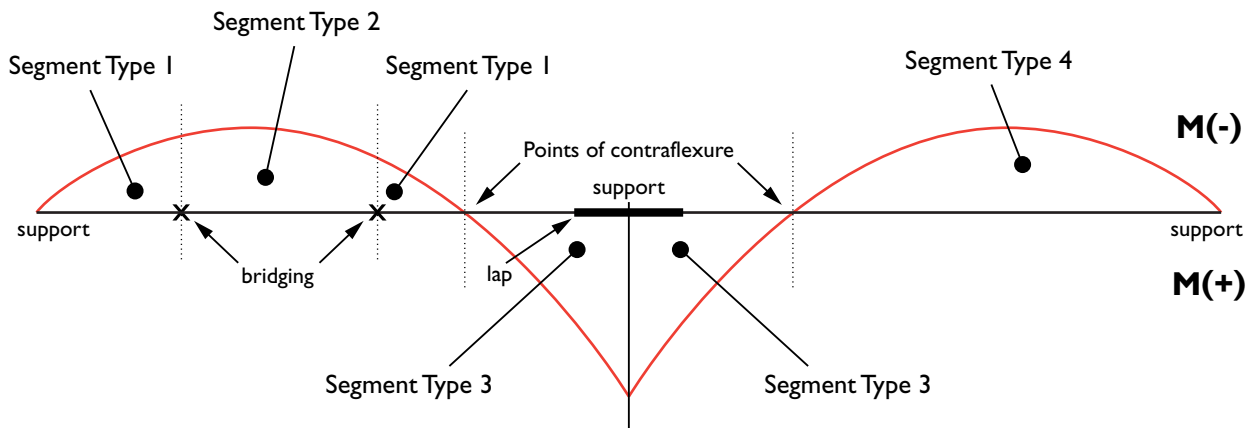

**Typical Bending Moment Diagram – double span outwards loading case**

Aspects of this design methodology are subject to a patent application.

### Member Moment Capacity Tables

Member Moment Design Capacity tables for **Stramit Exacta® Purlins and Girts**, in Limit-State Format, are as follows:

Table 14 – Section Capacities

Table 15 – Segment Type 1  
(zero moment to positive moment segments)

Table 16 – Segment Type 2  
(positive moment to positive moment segments)

Table 17 – Segment Type 3  
(negative moment to zero moment segments)

Table 18 – Segment Type 4  
(zero moment to zero moment segments)

Table 19 – Axial Compression, no bridging/bracing

Table 20 – Axial Compression, one row bridging

Table 21 – Axial Compression, two rows bridging

Table 22 – Axial Compression, three rows bridging

**Table 14**

<b>STRAMIT EXACTA® PURLINS – Section Capacities</b>		
<b>Section</b>	$\phi_b M_s$ <b>(kNm)</b>	$\phi_v V_v$ <b>(kN)</b>
EC/EZ150-10	5.12	6.30
EC/EZ150-12	6.36	10.9
EC/EZ150-15	7.76	21.4
EC/EZ150-19	10.4	43.8
EC/EZ150-24	13.8	72.7
EC/EZ200-12	8.60	8.01
EC/EZ200-15	11.4	15.7
EC/EZ200-19	16.4	32.0
EC/EZ200-24	22.0	64.9
EC/EZ250-15	14.3	12.4
EC/EZ250-19	20.7	25.3
EC/EZ250-24	29.1	51.1
EC/EZ300-19	27.5	20.8
EC/EZ300-24	39.8	42.2
EC/EZ300-30	54.9	82.7
EC/EZ350-19	34.8	17.7
EC/EZ350-24	49.8	35.9
EC/EZ350-30	71.5	70.3

**Member Moment Capacity Tables**

Member Moment Design Capacity tables for **Stramit Exacta® C&Z Purlins and Girts**, in Limit-State Format:

**Table 15**

		<b>STRAMIT EXACTA® C&amp;Z PURLINS – <math>\phi_b M_b</math></b>																	
		<b>Moment Design Capacity (kNm) Segment Type 1</b>																	
Moment	Segment Length: L (mm)	Stramit Exacta® EC/EZ Purlin/Girt Size																	
		150-10	150-12	150-15	150-19	150-24	200-12	200-15	200-19	200-24	250-15	250-19	250-24	300-19	300-24	300-30	350-19	350-24	350-30
M(+)	All	4.04	4.97	6.38	8.84	12.1	7.07	9.22	13.4	18.6	12.1	17.1	23.9	23.2	32.7	46.1	29.9	42.3	58.7
M(-)	1000	4.04	4.97	6.38	8.84	12.1	7.07	9.22	13.4	18.6	12.1	17.1	23.9	23.2	32.7	46.1	29.9	42.3	58.7
	1200	4.04	4.97	6.38	8.84	12.1	7.07	9.22	13.4	18.6	12.1	17.1	23.9	23.2	32.7	46.1	29.9	42.3	58.7
	1400	4.04	4.97	6.38	8.84	12.1	7.07	9.22	13.4	18.6	12.1	17.1	23.9	23.2	32.7	46.1	29.9	42.3	58.7
	1600	4.04	4.97	6.38	8.84	12.1	7.07	9.22	13.4	18.6	12.1	17.1	23.9	23.2	32.7	46.1	29.9	42.3	58.7
	1800	4.04	4.97	6.38	8.84	11.7	7.07	9.22	13.4	18.6	12.1	17.1	23.9	23.2	32.7	46.1	29.9	42.3	58.7
	2000	4.04	4.97	6.38	8.79	11.1	7.07	9.22	13.4	18.6	12.1	17.1	23.9	23.2	32.7	46.1	29.9	42.3	58.7
	2200	3.83	4.94	6.06	8.25	10.5	7.07	9.22	13.4	18.6	12.1	17.1	23.9	23.2	32.7	46.1	29.9	42.3	58.7
	2400	3.56	4.56	5.73	7.66	9.78	7.00	9.22	13.3	18.4	12.1	17.1	23.9	23.2	32.7	46.1	29.9	42.3	58.7
	2600	3.27	4.13	5.37	7.03	9.05	6.71	9.19	12.7	17.6	11.8	16.8	23.1	23.2	32.7	46.1	29.9	42.3	58.7
	2800	2.89	3.68	4.88	6.37	8.27	6.39	8.66	12.1	16.6	11.3	15.9	21.9	23.2	32.7	46.1	29.9	42.3	58.7
	3000	2.57	3.27	4.34	5.67	7.47	6.04	8.09	11.6	15.5	10.8	15.0	20.6	23.2	32.7	46.1	29.9	42.3	58.7
	3200	2.31	2.93	3.84	5.03	6.67	5.65	7.48	11.0	14.3	10.2	14.1	18.9	23.1	32.7	45.7	29.9	42.3	58.7
	3400	2.09	2.64	3.42	4.50	5.99	5.27	6.83	10.1	13.1	9.65	13.0	17.1	22.5	31.5	44.4	29.9	42.3	58.7
	3600	1.89	2.39	3.07	4.05	5.42	4.81	6.22	9.07	11.8	8.79	11.8	15.4	21.8	30.1	42.6	29.9	42.3	58.7
	3800	1.72	2.16	2.78	3.68	4.94	4.41	5.77	8.18	10.7	8.05	10.6	13.9	21.1	28.6	40.3	29.9	42.3	58.7
	4000	1.58	1.96	2.53	3.36	4.53	4.05	5.39	7.42	9.71	7.49	9.60	12.6	20.3	27.2	37.9	29.4	42.2	58.4
	4200	1.45	1.79	2.31	3.08	4.17	3.73	4.91	6.77	8.88	6.84	8.74	11.5	19.4	25.8	35.4	28.8	41.4	56.6
	4400	1.33	1.64	2.12	2.84	3.86	3.44	4.49	6.20	8.16	6.25	8.00	10.5	18.1	24.4	32.9	28.1	40.5	54.8
	4600	1.23	1.51	1.96	2.63	3.59	3.19	4.12	5.71	7.53	5.73	7.35	9.70	16.8	22.7	30.3	27.4	39.5	52.9
	4800	1.13	1.39	1.81	2.44	3.35	2.97	3.80	5.27	6.98	5.28	6.78	8.97	15.7	20.9	27.9	26.7	38.5	50.8
5000	1.05	1.29	1.68	2.28	3.14	2.75	3.52	4.89	6.49	4.88	6.28	8.32	14.7	19.3	25.8	25.9	37.4	48.7	

**Table 16**

		<b>STRAMIT EXACTA® C&amp;Z PURLINS – <math>\phi_b M_b</math></b>																	
		<b>Moment Design Capacity (kNm) Segment Type 2</b>																	
Moment	Segment Length: L (mm)	Stramit Exacta® EC/EZ Purlin/Girt Size																	
		150-10	150-12	150-15	150-19	150-24	200-12	200-15	200-19	200-24	250-15	250-19	250-24	300-19	300-24	300-30	350-19	350-24	350-30
M(+)	All	4.04	4.97	6.38	8.84	12.1	7.07	9.22	13.4	18.6	12.1	17.1	23.9	23.2	32.7	46.1	29.9	42.3	58.7
M(-)	1000	4.04	4.97	6.38	8.84	12.1	7.07	9.22	13.4	18.6	12.1	17.1	23.9	23.2	32.7	46.1	29.9	42.3	58.7
	1200	4.04	4.97	6.38	8.84	12.1	7.07	9.22	13.4	18.6	12.1	17.1	23.9	23.2	32.7	46.1	29.9	42.3	58.7
	1400	4.04	4.97	6.38	8.84	12.1	7.07	9.22	13.4	18.6	12.1	17.1	23.9	23.2	32.7	46.1	29.9	42.3	58.7
	1600	4.04	4.97	6.38	8.84	11.6	7.07	9.22	13.4	18.6	12.1	17.1	23.9	23.2	32.7	46.1	29.9	42.3	58.7
	1800	4.02	4.97	6.32	8.66	10.9	7.07	9.22	13.4	18.6	12.1	17.1	23.9	23.2	32.7	46.1	29.9	42.3	58.7
	2000	3.74	4.81	5.92	8.02	10.2	7.07	9.22	13.4	18.6	12.1	17.1	23.9	23.2	32.7	46.1	29.9	42.3	58.7
	2200	3.42	4.35	5.57	7.33	9.36	6.86	9.22	13.0	18.0	12.0	17.1	23.7	23.2	32.7	46.1	29.9	42.3	58.7
	2400	3.02	3.85	5.05	6.57	8.47	6.52	8.86	12.3	16.9	11.5	16.2	22.4	23.2	32.7	46.1	29.9	42.3	58.7
	2600	2.64	3.35	4.44	5.77	7.53	6.13	8.23	11.7	15.7	10.9	15.2	20.9	23.2	32.7	46.1	29.9	42.3	58.7
	2800	2.33	2.95	3.85	5.02	6.60	5.69	7.53	11.0	14.3	10.3	14.2	19.0	23.2	32.7	45.8	29.9	42.3	58.7
	3000	2.07	2.62	3.38	4.41	5.83	5.25	6.79	10.0	12.9	9.62	12.9	16.9	22.5	31.4	44.3	29.9	42.3	58.7
	3200	1.86	2.34	2.99	3.91	5.19	4.74	6.11	8.85	11.5	8.65	11.5	15.0	21.7	29.8	42.2	29.9	42.3	58.7
	3400	1.67	2.08	2.66	3.50	4.66	4.29	5.64	7.87	10.2	7.88	10.2	13.3	20.8	28.1	39.5	29.8	42.3	58.7
	3600	1.51	1.86	2.39	3.16	4.22	3.90	5.14	7.06	9.19	7.19	9.15	12.0	19.9	26.6	36.7	29.1	41.9	57.6
	3800	1.38	1.68	2.16	2.86	3.85	3.55	4.63	6.37	8.31	6.47	8.24	10.8	18.6	24.9	33.8	28.4	40.9	55.6
	4000	1.25	1.52	1.97	2.61	3.53	3.25	4.19	5.78	7.56	5.85	7.47	9.80	17.1	23.1	30.8	27.6	39.8	53.4
	4200	1.14	1.39	1.80	2.40	3.25	2.99	3.82	5.27	6.91	5.32	6.80	8.94	15.8	21.0	28.0	26.8	38.6	51.1
	4400	1.04	1.27	1.65	2.21	3.01	2.74	3.49	4.83	6.35	4.86	6.22	8.20	14.7	19.2	25.6	26.0	37.4	48.7
	4600	0.95	1.17	1.52	2.04	2.80	2.51	3.21	4.44	5.86	4.46	5.72	7.55	13.7	17.6	23.6	25.0	35.5	46.1
	4800	0.88	1.08	1.41	1.90	2.61	2.32	2.96	4.10	5.43	4.11	5.28	6.98	12.6	16.3	21.7	24.0	33.4	43.8
5000	0.82	1.00	1.31	1.77	2.45	2.14	2.74	3.81	5.05	3.80	4.89	6.48	11.7	15.0	20.1	22.8	31.3	41.5	

NOTE: TABLES 15 to 18.

Capacities in **bold italics** are limited by distortional buckling.

\*Capacities in Table 18 can be doubled at the support as this is within the lap.

Outside of **Stramit® Bridging** recommendations.

**Table 17**

<b>STRAMIT EXACTA® C&amp;Z PURLINS – <math>\phi_b M_b</math></b>																			
<b>Moment Design Capacity (kNm) Segment Type 3</b>																			
Moment	Segment Length: L (mm)	Stramit Exacta® EC/EZ Purlin/Girt Size																	
		150-10	150-12	150-15	150-19	150-24	200-12	200-15	200-19	200-24	250-15	250-19	250-24	300-19	300-24	300-30	350-19	350-24	350-30
M(+)	All	<b>4.04</b>	<b>4.97</b>	<b>6.38</b>	<b>8.84</b>	<b>12.1</b>	<b>7.07</b>	<b>9.22</b>	<b>13.4</b>	<b>18.6</b>	<b>12.1</b>	<b>17.1</b>	<b>23.9</b>	<b>23.2</b>	<b>32.7</b>	<b>46.1</b>	<b>29.9</b>	<b>42.3</b>	<b>58.7</b>
M(-)	1000	<b>4.04</b>	<b>4.97</b>	<b>6.38</b>	<b>8.84</b>	<b>12.1</b>	<b>7.07</b>	<b>9.22</b>	<b>13.4</b>	<b>18.6</b>	<b>12.1</b>	<b>17.1</b>	<b>23.9</b>	<b>23.2</b>	<b>32.7</b>	<b>46.1</b>	<b>29.9</b>	<b>42.3</b>	<b>58.7</b>
	1200	<b>4.04</b>	<b>4.97</b>	<b>6.38</b>	<b>8.84</b>	<b>12.1</b>	<b>7.07</b>	<b>9.22</b>	<b>13.4</b>	<b>18.6</b>	<b>12.1</b>	<b>17.1</b>	<b>23.9</b>	<b>23.2</b>	<b>32.7</b>	<b>46.1</b>	<b>29.9</b>	<b>42.3</b>	<b>58.7</b>
	1400	<b>4.04</b>	<b>4.97</b>	<b>6.38</b>	<b>8.84</b>	<b>12.1</b>	<b>7.07</b>	<b>9.22</b>	<b>13.4</b>	<b>18.6</b>	<b>12.1</b>	<b>17.1</b>	<b>23.9</b>	<b>23.2</b>	<b>32.7</b>	<b>46.1</b>	<b>29.9</b>	<b>42.3</b>	<b>58.7</b>
	1600	<b>4.04</b>	<b>4.97</b>	<b>6.38</b>	<b>8.84</b>	<b>12.1</b>	<b>7.07</b>	<b>9.22</b>	<b>13.4</b>	<b>18.6</b>	<b>12.1</b>	<b>17.1</b>	<b>23.9</b>	<b>23.2</b>	<b>32.7</b>	<b>46.1</b>	<b>29.9</b>	<b>42.3</b>	<b>58.7</b>
	1800	<b>4.04</b>	<b>4.97</b>	<b>6.38</b>	<b>8.84</b>	<b>12.1</b>	<b>7.07</b>	<b>9.22</b>	<b>13.4</b>	<b>18.6</b>	<b>12.1</b>	<b>17.1</b>	<b>23.9</b>	<b>23.2</b>	<b>32.7</b>	<b>46.1</b>	<b>29.9</b>	<b>42.3</b>	<b>58.7</b>
	2000	<b>4.04</b>	<b>4.97</b>	<b>6.38</b>	<b>8.84</b>	<b>12.0</b>	<b>7.07</b>	<b>9.22</b>	<b>13.4</b>	<b>18.6</b>	<b>12.1</b>	<b>17.1</b>	<b>23.9</b>	<b>23.2</b>	<b>32.7</b>	<b>46.1</b>	<b>29.9</b>	<b>42.3</b>	<b>58.7</b>
	2200	<b>4.04</b>	<b>4.97</b>	<b>6.38</b>	<b>8.84</b>	11.5	<b>7.07</b>	<b>9.22</b>	<b>13.4</b>	<b>18.6</b>	<b>12.1</b>	<b>17.1</b>	<b>23.9</b>	<b>23.2</b>	<b>32.7</b>	<b>46.1</b>	<b>29.9</b>	<b>42.3</b>	<b>58.7</b>
	2400	<b>4.02</b>	<b>4.97</b>	6.34	8.72	11.0	<b>7.07</b>	<b>9.22</b>	<b>13.4</b>	<b>18.6</b>	<b>12.1</b>	<b>17.1</b>	<b>23.9</b>	<b>23.2</b>	<b>32.7</b>	<b>46.1</b>	<b>29.9</b>	<b>42.3</b>	<b>58.7</b>
	2600	3.82	4.93	6.05	8.26	10.5	<b>7.07</b>	<b>9.22</b>	<b>13.4</b>	<b>18.6</b>	<b>12.1</b>	<b>17.1</b>	<b>23.9</b>	<b>23.2</b>	<b>32.7</b>	<b>46.1</b>	<b>29.9</b>	<b>42.3</b>	<b>58.7</b>
	2800	3.60	4.61	5.78	7.78	10.0	7.03	<b>9.22</b>	<b>13.4</b>	<b>18.5</b>	<b>12.1</b>	<b>17.1</b>	<b>23.9</b>	<b>23.2</b>	<b>32.7</b>	<b>46.1</b>	<b>29.9</b>	<b>42.3</b>	<b>58.7</b>
	3000	3.35	4.26	5.52	7.27	9.37	6.79	<b>9.22</b>	12.9	17.9	11.9	<b>17.0</b>	23.5	<b>23.2</b>	<b>32.7</b>	<b>46.1</b>	<b>29.9</b>	<b>42.3</b>	<b>58.7</b>
	3200	3.04	3.89	5.13	6.73	8.76	6.53	8.89	12.4	17.1	11.5	16.3	22.5	<b>23.2</b>	<b>32.7</b>	<b>46.1</b>	<b>29.9</b>	<b>42.3</b>	<b>58.7</b>
	3400	2.75	3.51	4.70	6.17	8.12	6.25	8.43	11.9	16.2	11.1	15.5	21.4	<b>23.2</b>	<b>32.7</b>	<b>46.1</b>	<b>29.9</b>	<b>42.3</b>	<b>58.7</b>
	3600	2.51	3.19	4.24	5.60	7.47	5.94	7.94	11.4	15.3	10.7	14.8	20.2	<b>23.2</b>	<b>32.7</b>	<b>46.1</b>	<b>29.9</b>	<b>42.3</b>	<b>58.7</b>
	3800	2.29	2.91	3.84	5.08	6.83	5.60	7.42	10.9	14.3	10.2	14.0	18.8	23.0	<b>32.6</b>	45.6	<b>29.9</b>	<b>42.3</b>	<b>58.7</b>
	4000	2.10	2.67	3.49	4.63	6.26	5.29	6.87	10.2	13.3	9.68	13.1	17.3	22.5	31.5	44.5	<b>29.9</b>	<b>42.3</b>	<b>58.7</b>
	4200	1.93	2.46	3.19	4.25	5.76	4.90	6.36	9.35	12.3	8.95	12.1	15.9	21.9	30.4	43.1	<b>29.9</b>	<b>42.3</b>	<b>58.7</b>
	4400	1.79	2.26	2.93	3.92	5.34	4.55	5.94	8.57	11.3	8.30	11.0	14.5	21.3	29.2	41.3	<b>29.9</b>	<b>42.3</b>	<b>58.7</b>
	4600	1.66	2.08	2.70	3.63	4.96	4.24	5.61	7.88	10.4	7.79	10.1	13.4	20.7	27.9	39.3	29.6	<b>42.3</b>	<b>58.7</b>
4800	1.54	1.92	2.50	3.37	4.63	3.95	5.25	7.28	9.64	7.29	9.36	12.4	20.0	26.8	37.3	29.1	41.9	57.8	
5000	1.44	1.78	2.33	3.15	4.34	3.68	4.86	6.75	8.96	6.74	8.67	11.5	19.2	25.6	35.2	28.6	41.2	56.3	

**Table 18**

<b>STRAMIT EXACTA® C&amp;Z PURLINS – <math>\phi_b M_b</math></b>																			
<b>Moment Design Capacity (kNm) Segment Type 4</b>																			
Moment	Segment Length: L (mm)	Stramit Exacta® EC/EZ Purlin/Girt Size																	
		150-10	150-12	150-15	150-19	150-24	200-12	200-15	200-19	200-24	250-15	250-19	250-24	300-19	300-24	300-30	350-19	350-24	350-30
M(+)	All	<b>4.04</b>	<b>4.97</b>	<b>6.38</b>	<b>8.84</b>	<b>12.1</b>	<b>7.07</b>	<b>9.22</b>	<b>13.4</b>	<b>18.6</b>	<b>12.1</b>	<b>17.1</b>	<b>23.9</b>	<b>23.2</b>	<b>32.7</b>	<b>46.1</b>	<b>29.9</b>	<b>42.3</b>	<b>58.7</b>
M(-)	1000	<b>4.04</b>	<b>4.97</b>	<b>6.38</b>	<b>8.84</b>	<b>12.1</b>	<b>7.07</b>	<b>9.22</b>	<b>13.4</b>	<b>18.6</b>	<b>12.1</b>	<b>17.1</b>	<b>23.9</b>	<b>23.2</b>	<b>32.7</b>	<b>46.1</b>	<b>29.9</b>	<b>42.3</b>	<b>58.7</b>
	1200	<b>4.04</b>	<b>4.97</b>	<b>6.38</b>	<b>8.84</b>	<b>12.1</b>	<b>7.07</b>	<b>9.22</b>	<b>13.4</b>	<b>18.6</b>	<b>12.1</b>	<b>17.1</b>	<b>23.9</b>	<b>23.2</b>	<b>32.7</b>	<b>46.1</b>	<b>29.9</b>	<b>42.3</b>	<b>58.7</b>
	1400	<b>4.04</b>	<b>4.97</b>	<b>6.38</b>	<b>8.84</b>	<b>12.1</b>	<b>7.07</b>	<b>9.22</b>	<b>13.4</b>	<b>18.6</b>	<b>12.1</b>	<b>17.1</b>	<b>23.9</b>	<b>23.2</b>	<b>32.7</b>	<b>46.1</b>	<b>29.9</b>	<b>42.3</b>	<b>58.7</b>
	1600	<b>4.04</b>	<b>4.97</b>	<b>6.38</b>	<b>8.84</b>	<b>11.9</b>	<b>7.07</b>	<b>9.22</b>	<b>13.4</b>	<b>18.6</b>	<b>12.1</b>	<b>17.1</b>	<b>23.9</b>	<b>23.2</b>	<b>32.7</b>	<b>46.1</b>	<b>29.9</b>	<b>42.3</b>	<b>58.7</b>
	1800	<b>4.04</b>	<b>4.97</b>	<b>6.38</b>	<b>8.84</b>	11.3	<b>7.07</b>	<b>9.22</b>	<b>13.4</b>	<b>18.6</b>	<b>12.1</b>	<b>17.1</b>	<b>23.9</b>	<b>23.2</b>	<b>32.7</b>	<b>46.1</b>	<b>29.9</b>	<b>42.3</b>	<b>58.7</b>
	2000	3.90	<b>4.97</b>	6.16	8.41	10.6	<b>7.07</b>	<b>9.22</b>	<b>13.4</b>	<b>18.6</b>	<b>12.1</b>	<b>17.1</b>	<b>23.9</b>	<b>23.2</b>	<b>32.7</b>	<b>46.1</b>	<b>29.9</b>	<b>42.3</b>	<b>58.7</b>
	2200	3.63	4.65	5.80	7.78	9.91	7.06	<b>9.22</b>	<b>13.4</b>	<b>18.6</b>	<b>12.1</b>	<b>17.1</b>	<b>23.9</b>	<b>23.2</b>	<b>32.7</b>	<b>46.1</b>	<b>29.9</b>	<b>42.3</b>	<b>58.7</b>
	2400	3.31	4.20	5.44	7.11	9.12	6.76	<b>9.22</b>	12.8	17.7	11.8	16.9	23.3	<b>23.2</b>	<b>32.7</b>	<b>46.1</b>	<b>29.9</b>	<b>42.3</b>	<b>58.7</b>
	2600	2.92	3.71	4.91	6.40	8.29	6.42	8.71	12.2	16.6	11.4	16.0	22.0	<b>23.2</b>	<b>32.7</b>	<b>46.1</b>	<b>29.9</b>	<b>42.3</b>	<b>58.7</b>
	2800	2.58	3.27	4.33	5.64	7.41	6.05	8.10	11.6	15.4	10.8	15.0	20.6	<b>23.2</b>	<b>32.7</b>	<b>46.1</b>	<b>29.9</b>	<b>42.3</b>	<b>58.7</b>
	3000	2.30	2.91	3.80	4.96	6.55	5.63	7.44	10.9	14.2	10.2	14.0	18.8	23.1	<b>32.7</b>	45.7	<b>29.9</b>	<b>42.3</b>	<b>58.7</b>
	3200	2.06	2.60	3.36	4.40	5.84	5.21	6.74	9.93	12.8	9.54	12.8	16.8	22.4	31.3	44.1	<b>29.9</b>	<b>42.3</b>	<b>58.7</b>
	3400	1.85	2.34	2.99	3.94	5.24	4.73	6.11	8.85	11.5	8.63	11.5	15.0	21.7	29.8	42.1	<b>29.9</b>	<b>42.3</b>	<b>58.7</b>
	3600	1.68	2.09	2.69	3.55	4.75	4.31	5.66	7.93	10.3	7.90	10.3	13.4	20.9	28.2	39.7	<b>29.8</b>	<b>42.3</b>	<b>58.7</b>
	3800	1.53	1.89	2.43	3.22	4.32	3.94	5.21	7.16	9.34	7.27	9.27	12.1	20.0	26.7	37.0	29.2	42.0	57.8
	4000	1.40	1.71	2.21	2.94	3.96	3.60	4.72	6.49	8.50	6.58	8.40	11.0	18.9	25.2	34.3	28.5	41.0	55.9
	4200	1.28	1.56	2.02	2.69	3.65	3.31	4.29	5.92	7.77	5.98	7.65	10.1	17.4	23.6	31.5	27.8	40.0	53.9
	4400	1.17	1.43	1.86	2.48	3.38	3.06	3.93	5.43	7.14	5.47	7.00	9.22	16.2	21.6	28.8	27.0	39.0	51.8
	4600	1.07	1.32	1.71	2.30	3.14	2.83	3.61	4.99	6.59	5.02	6.43	8.49	15.0	19.8	26.5	26.2	37.8	49.5
4800	0.99	1.22	1.59	2.14	2.93	2.60	3.33	4.61	6.11	4.62	5.93	7.85	14.1	18.3	24.4	25.4	36.3	47.1	
5000	0.92	1.13	1.47	1.99	2.75	2.41	3.08	4.28	5.68	4.27	5.49	7.28	13.1	16.9	22.6	24.5	34.4	44.8	

# Design Example I

## Configuration

Consider a double span lapped purlin system with a 2.26 kN/m uplift load, on 9100 and 7400 spans.

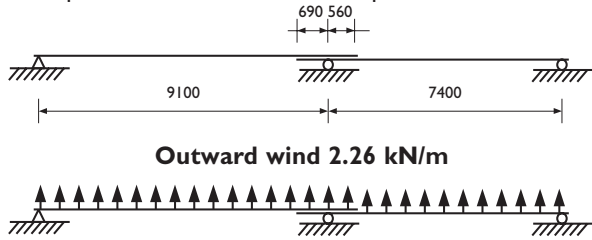

Assume a Stramit standard lap of 15% (7.5% for each span), that is, 682.5 for the 9100 span (rounded to 690) and 555 lap (say 560mm) for the 7400 span.

## Bending Moment Diagram

Using a nominal purlin section for both spans (say EZ250-24s) double the values of the laps and create the bending moment diagram using appropriate analysis software.

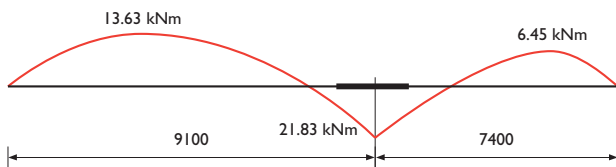

From the bending moment diagram, the purlin in each span is divided into two segments bounded by the point of contraflexure.

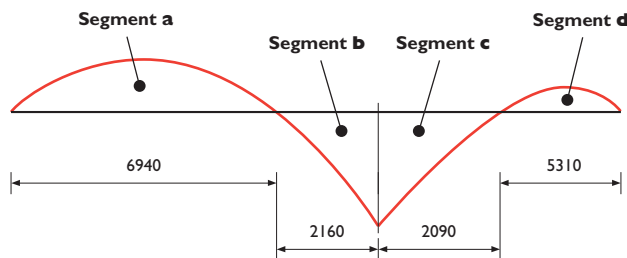

Check segments a, b, c and d for moment capacity. Segments b and c must be checked both at the end of the lap and at the internal support.

## Segment a

Now find the minimum purlin size for segment a (length 6940). The shape of the bending moment diagram makes this a Type 4 segment, so for a first approximation consider the maximum potential moment capacity or  $M(+)$  values in Table 18. There are two potential smallest sizes: EZ200-24 (7.21 kg/m) with a capacity of 18.6 kNm ( $>13.63$  kNm); and EZ250-19 (6.5 kg/m) with a capacity of 17.1 kNm ( $>13.63$  kNm).

For the lighter section EZ250-19 (6.5 kg/m), the “-ve” moment capacity  $M(-)$  of 14.9 kNm requires an unbraced length of 3200, much less than the length of the segment (6940). This indicates that bridging is needed to reduce the unbraced length. Using two rows of bridging allows

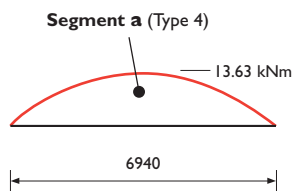

3200 for the central segment (the maximum unbraced length). Now the original Type 4 segment is transformed into two Type 1 segments and a Type 2 segment.

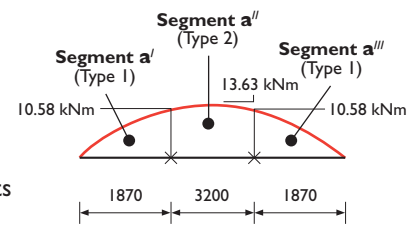

The new segments must be checked. The central segment a'' is now a Type 2 segment. In Table 16 for Type 2 segments, the EZ250-19 section provides a capacity of 12.8 kNm for a segment length of 3200, which is too low ( $<13.63$  kNm). The centre segment therefore needs to be reduced to 3000.

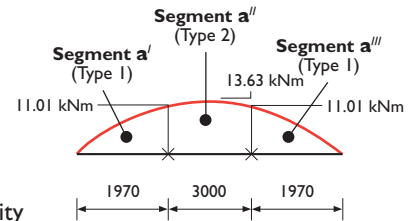

On the middle Type 2 segment with a reduced length of 3000, the EZ250-19 delivers a capacity of 14.0 kNm, exceeding 13.63 kNm, and is therefore OK. Segments a' and a'' are similar. With a Type 1 segment of 1970 unbraced length, the EZ250-19 section delivers a satisfactory moment capacity of 17.1 kNm ( $>11.01$  kNm) and is OK. However, this arrangement has created a right-hand bridging position with a length of 4130 (2160 + 1970) which exceeds Stramit's recommended bridging spacing of 4000.

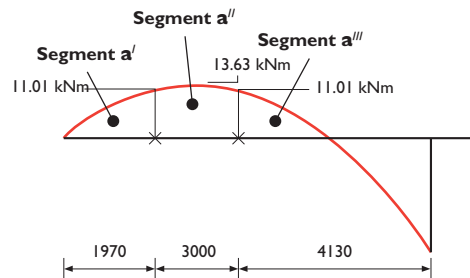

The bridging positions must be re-arranged to comply with the maximum unbraced length. Increasing the length of the left-hand segment to 2200 leaves 3900 at the other end, which is within the required four metres (otherwise, another row of bridging would need to be inserted instead).

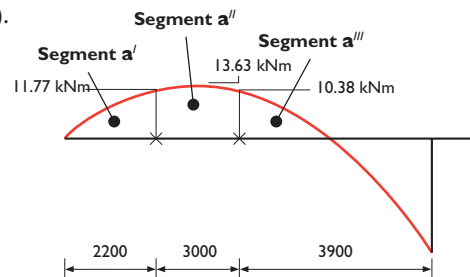

Again, check segments a', a'' and a'''. Segment a' now has a length of 2200 and being a Type 1 segment, still delivers a capacity of 17.1 kNm ( $>11.77$  kNm) and is therefore OK.

The middle segment a'' retains the same unbraced length of 3000, with the same maximum bending moment of 13.63 kNm and is also OK (Type 2,  $L_e = 3000$ ,  $M = 14.0 > 13.63$  kNm). Segment a''' is similar to a' and has less moment to resist, so it is also OK.



### Segment b

In segment b the unlappped portion up to the lap is 1470 and the required capacity is 13.62 kNm. This is a Type 3 segment (Table 17). For a segment length of 1470 the capacity is 17.1 kNm (>13.62 kNm). (Note that the lap length could potentially be reduced.) At the support, for a length of 2160 (2 x EZ250-19 as there are two thicknesses of purlin within the lap) the capacity is  $17.1 \times 2 = 34.2$  kNm and therefore OK (>21.83 kNm).

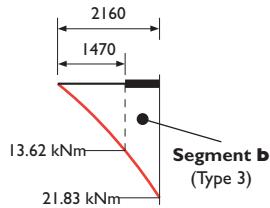

### Segment c

In segment c the required capacity is 15.85 kNm over the unlappped portion of 1530. There is no need to check the right side of the segment, which was already checked in segment b. In Table 17 for Type 3 segments, the “+ve” capacity was found to be 17.1 kNm (>15.85 kNm) and, in this case, the segment length for “+ve” works for any segment length. Note that if this section were found to be inadequate, the lap could be increased accordingly.

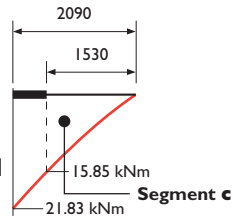

### Segment d

Segment d carries a “-ve” moment of 6.45 kNm over the unbraced length of 5310. In Table 18 for Type 4 segments, the EZ250-19 gives 6.23 kNm capacity, which is less than the required 6.45 kNm. The segment length needs to be reduced. In addition, this segment length exceeds Stramit's recommendation. Therefore, one row of bridging will be required. Inserting a row of bridging at mid-span modifies the segment lengths and the segment types. Two new Type 1 segments are generated and both segments need to be checked.

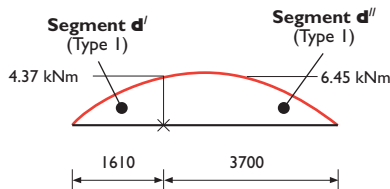
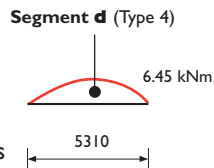

For the new segment d' the assumed length is 1610. Table 15 for Type 1 segments gives a capacity of 17.1 kNm, well above the required capacity of 4.37 kNm, therefore OK. The new segment d'' requires a capacity of 6.45 kNm. For an unbraced length of 3700 the Type 1 table gives 12.55 kNm  $[(13.1 + 12.0)/2]$  which is more than the required 6.45 kNm and therefore OK.

### Recheck

If any lap length is increased, the BMD and SFD must be regenerated and all segment moment capacities rechecked.

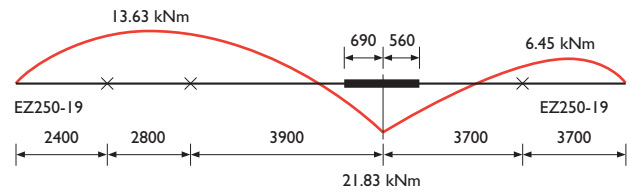

### Inward Loading Condition

Use the same procedure to check the inward case. Unless the moments from inward loading are greater, the “mid-span” segments (which now have “+ve” moments) must be OK. However, as the support and lap region moments are now “-ve” these need to be checked.

### Bolt Capacity Check

The reaction at the internal support, obtained from the shear force diagram (SFD), is 23.0kN (11.3+12.7). Try M12 grade 4.6 bolts. From Table 4, the bolt shear/bearing capacity (for two bolts) is 30.3kN, which is OK.

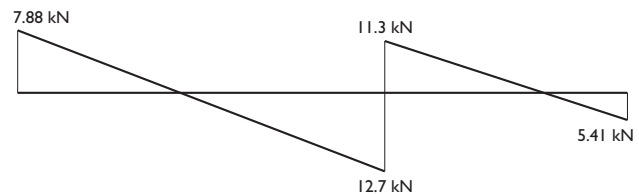

### Combined Bending and Shear

There are three checks needed for combined bending and shear - immediately outside each lap and at the central support cleat. The  $V^*$  values are found from the final SFD diagrams.  $\phi_b M_s$  and  $\phi_v V_v$  capacities are obtained from Table 14.

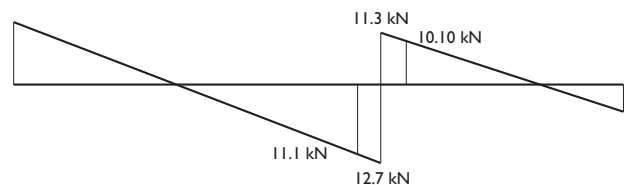

Check the end of left lap:

$$\left(\frac{M^*}{\phi_b M_s}\right)^2 + \left(\frac{V^*}{\phi_v V_v}\right)^2 = \left(\frac{13.62}{20.7}\right)^2 + \left(\frac{11.1}{25.3}\right)^2 = 0.625 < 1.0, \text{ OK}$$

Check the internal support:

$$\left(\frac{M^*}{\phi_b M_s}\right)^2 + \left(\frac{V^*}{\phi_v V_v}\right)^2 = \left(\frac{21.83}{2 \times 20.7}\right)^2 + \left(\frac{12.7}{2 \times 25.3}\right)^2 = 0.341 < 1.0, \text{ OK}$$

Check the end of right lap:

$$\left(\frac{M^*}{\phi_b M_s}\right)^2 + \left(\frac{V^*}{\phi_v V_v}\right)^2 = \left(\frac{15.85}{20.7}\right)^2 + \left(\frac{10.10}{25.3}\right)^2 = 0.746 < 1.0, \text{ OK}$$

NOTES: TABLES 19

1. The numbers in **bold italics** are limited by the slenderness ratio in clause 3.4.1 of AS/NZS4600:2005
2. Effective length should be assumed to equal the span (for continuous purlins this assumption is conservative)

Outside **Stramit® Bridging** recommendations.

**Table 19**

<b>STRAMIT EXACTA® PURLINS – DESIGN MEMBER CAPACITIES FOR AXIAL COMPRESSION No intermediate bracing - <math>\phi_c N_c</math> (kN)</b>																		
Effective Length (mm)	Stramit® Exacta® Purlin/Girt Size																	
	EC150-10	EC150-12	EC150-15	EC150-19	EC150-24	EC200-12	EC200-15	EC200-19	EC200-24	EC250-15	EC250-19	EC250-24	EC300-19	EC300-24	EC300-30	EC350-19	EC350-24	EC350-30
1000	57.6	72.3	93.6	135	184	74.5	96.6	144	218	103	142	215	171	238	345	188	262	364
1500	44.4	57.2	77.6	107	148	65.0	85.4	130	191	91.9	127	195	160	223	342	181	251	349
2000	31.1	41.3	56.5	78.9	111	53.7	71.7	113	156	78.8	114	160	147	203	310	170	236	329
2500	22.4	28.8	39.5	55.9	78.9	42.0	59.4	86.5	121	65.5	89.5	124	130	185	265	158	219	304
3000	16.6	21.4	29.6	42.3	56.6	32.3	44.0	64.7	91.7	48.9	66.4	92.0	113	159	220	144	199	277
3500	12.9	16.7	23.3	32.7	41.6	25.0	34.3	50.8	71.6	37.7	51.4	71.3	92.8	126	176	128	178	255
4000	10.4	13.6	19.1	25.3	31.9	20.1	27.8	41.4	57.0	30.2	41.2	57.3	74.0	101	141	111	157	225
4500	<b>8.64</b>	<b>11.3</b>	<b>15.7</b>	<b>20.0</b>	<b>25.2</b>	16.7	23.1	34.4	46.6	24.8	34.0	47.1	60.6	83.0	116	94.2	137	187
5000	<b>7.34</b>	<b>9.69</b>	<b>12.8</b>	<b>16.2</b>	<b>20.4</b>	<b>14.1</b>	<b>19.7</b>	<b>28.8</b>	<b>38.3</b>	20.9	28.6	39.6	50.8	69.7	97.4	81.3	115	158
5500	<b>6.36</b>	<b>8.37</b>	<b>10.6</b>	<b>13.4</b>	<b>16.9</b>	<b>12.2</b>	<b>17.1</b>	<b>24.4</b>	<b>31.6</b>	<b>17.8</b>	<b>24.4</b>	<b>33.7</b>	43.4	59.5	83.1	71.0	98.5	136
6000	<b>5.58</b>	<b>7.14</b>	<b>8.91</b>	<b>11.3</b>	<b>14.2</b>	<b>10.7</b>	<b>14.9</b>	<b>21.0</b>	<b>26.6</b>	<b>15.5</b>	<b>21.2</b>	<b>29.0</b>	37.5	51.6	71.9	61.5	85.7	119
6500	<b>4.97</b>	<b>6.08</b>	<b>7.59</b>	<b>9.59</b>	<b>12.1</b>	<b>9.46</b>	<b>13.0</b>	<b>18.0</b>	<b>22.7</b>	<b>13.6</b>	<b>18.5</b>	<b>24.7</b>	32.9	45.2	62.8	54.0	75.5	105
7000	<b>4.37</b>	<b>5.24</b>	<b>6.54</b>	<b>8.27</b>	<b>10.4</b>	<b>8.48</b>	<b>11.4</b>	<b>15.5</b>	<b>19.5</b>	<b>12.0</b>	<b>16.3</b>	<b>21.3</b>	<b>29.1</b>	<b>39.9</b>	<b>55.4</b>	47.9	67.2	94.3
7500	<b>3.81</b>	<b>4.57</b>	<b>5.70</b>	<b>7.20</b>	<b>9.06</b>	<b>7.59</b>	<b>10.1</b>	<b>13.5</b>	<b>17.0</b>	<b>10.7</b>	<b>14.5</b>	<b>18.5</b>	<b>26.0</b>	<b>35.6</b>	<b>49.2</b>	42.9	60.4	84.4
8000	<b>3.35</b>	<b>4.02</b>	<b>5.01</b>	<b>6.33</b>	<b>7.97</b>	<b>6.80</b>	<b>8.93</b>	<b>11.9</b>	<b>15.0</b>	<b>9.62</b>	<b>12.8</b>	<b>16.3</b>	<b>23.3</b>	<b>31.9</b>	<b>43.2</b>	38.7	54.8	75.7
	EZ150-10	EZ150-12	EZ150-15	EZ150-19	EZ150-24	EZ200-12	EZ200-15	EZ200-19	EZ200-24	EZ250-15	EZ250-19	EZ250-24	EZ300-19	EZ300-24	EZ300-30	EZ350-19	EZ350-24	EZ350-30
1000	54.0	68.0	87.1	127	172	73.1	94.4	140	212	97.1	137	205	163	228	339	186	258	360
1500	38.6	50.2	67.7	91.9	125	60.7	79.6	125	171	82.6	119	173	148	207	320	176	244	339
2000	25.4	32.8	43.7	59.5	80.9	46.3	63.9	92.6	126	65.6	94.3	129	130	183	272	163	225	312
2500	17.6	22.3	29.8	40.5	53.8	33.4	44.9	64.3	87.6	48.0	65.8	90.5	109	156	217	147	203	280
3000	12.9	16.3	21.8	29.3	37.3	24.6	33.0	47.2	64.3	35.3	48.7	67.0	86.4	118	165	128	178	253
3500	9.91	12.6	16.7	21.6	27.4	18.9	25.4	36.4	49.4	27.3	37.8	52.0	66.5	91.0	128	108	152	213
4000	<b>7.89</b>	<b>10.0</b>	<b>13.0</b>	<b>16.5</b>	<b>21.0</b>	15.1	20.3	29.0	38.8	21.9	30.3	41.7	53.2	72.9	102	89.2	126	170
4500	<b>6.45</b>	<b>8.13</b>	<b>10.3</b>	<b>13.0</b>	<b>16.6</b>	<b>12.4</b>	<b>16.7</b>	<b>23.7</b>	<b>30.6</b>	<b>18.1</b>	<b>25.0</b>	<b>34.2</b>	43.7	60.0	84.0	75.2	103	139
5000	<b>5.37</b>	<b>6.66</b>	<b>8.33</b>	<b>10.6</b>	<b>13.4</b>	<b>10.4</b>	<b>13.9</b>	<b>19.6</b>	<b>24.8</b>	<b>15.2</b>	<b>21.0</b>	<b>28.4</b>	36.7	50.4	70.5	63.5	86.5	117
5500	<b>4.55</b>	<b>5.50</b>	<b>6.89</b>	<b>8.73</b>	<b>11.1</b>	<b>8.83</b>	<b>11.8</b>	<b>16.2</b>	<b>20.5</b>	<b>13.0</b>	<b>17.9</b>	<b>23.5</b>	31.3	43.1	60.0	54.0	73.7	100
6000	<b>3.85</b>	<b>4.63</b>	<b>5.79</b>	<b>7.34</b>	<b>9.34</b>	<b>7.63</b>	<b>10.2</b>	<b>13.6</b>	<b>17.2</b>	<b>11.3</b>	<b>15.4</b>	<b>19.7</b>	<b>27.1</b>	<b>37.3</b>	<b>51.7</b>	46.6	63.8	86.2
6500	<b>3.28</b>	<b>3.94</b>	<b>4.93</b>	<b>6.25</b>	<b>7.96</b>	<b>6.66</b>	<b>8.72</b>	<b>11.6</b>	<b>14.7</b>	<b>9.9</b>	<b>13.3</b>	<b>16.8</b>	<b>23.8</b>	<b>32.6</b>	<b>44.4</b>	40.8	55.8	75.4
7000	<b>2.83</b>	<b>3.40</b>	<b>4.25</b>	<b>5.39</b>	<b>6.86</b>	<b>5.87</b>	<b>7.52</b>	<b>10.0</b>	<b>12.7</b>	<b>8.7</b>	<b>11.5</b>	<b>14.5</b>	<b>21.0</b>	<b>28.8</b>	<b>38.3</b>	<b>36.0</b>	<b>49.3</b>	<b>66.6</b>
7500	<b>2.47</b>	<b>2.96</b>	<b>3.70</b>	<b>4.70</b>	<b>5.98</b>	<b>5.21</b>	<b>6.55</b>	<b>8.72</b>	<b>11.0</b>	<b>7.8</b>	<b>10.0</b>	<b>12.6</b>	<b>18.8</b>	<b>25.6</b>	<b>33.3</b>	<b>32.1</b>	<b>44.0</b>	<b>59.3</b>
8000	<b>2.17</b>	<b>2.60</b>	<b>3.26</b>	<b>4.13</b>	<b>5.25</b>	<b>4.60</b>	<b>5.75</b>	<b>7.66</b>	<b>9.69</b>	<b>6.91</b>	<b>8.77</b>	<b>11.1</b>	<b>16.8</b>	<b>22.6</b>	<b>29.3</b>	<b>28.8</b>	<b>39.5</b>	<b>53.2</b>

NOTES: TABLES 20 to 22.

1. The numbers in **bold italics** are limited by the slenderness ratio in clause 3.4.1 of AS/NZS4600:2005

2. Braces are assumed to provide torsional restraint ( e.g. Stramit® Bridging ).

3. Use unbraced data ( Table 19 ) if bracing does not provide full torsional restraint.

Outside **Stramit® Bridging** recommendations.

**Table 20**

<b>STRAMIT EXACTA® PURLINS – DESIGN MEMBER CAPACITIES FOR AXIAL COMPRESSION One intermediate brace - <math>\phi_c N_c</math> (kN)</b>																		
Unbraced Length (mm)	Stramit® Exacta® Purlin/Girt Size																	
	EC150-10	EC150-12	EC150-15	EC150-19	EC150-24	EC200-12	EC200-15	EC200-19	EC200-24	EC250-15	EC250-19	EC250-24	EC300-19	EC300-24	EC300-30	EC350-19	EC350-24	EC350-30
1500	40.7	52.8	71.9	98.3	135	63.0	83.0	127	184	91.7	127	195	159	220	340	179	249	346
1750	33.3	44.1	59.8	82.4	114	57.0	75.7	120	164	85.4	121	178	152	210	326	174	241	336
2000	27.4	36.0	48.6	67.4	94.0	50.8	68.1	105	145	78.6	114	160	144	200	304	168	233	324
2250	23.0	29.5	40.0	55.7	77.9	44.5	61.9	90.9	126	71.5	103	142	136	191	282	162	224	311
2500	19.3	24.7	33.6	47.0	65.9	38.5	53.6	77.3	108	65.5	89.5	124	127	183	259	155	214	297
2750	16.5	21.1	28.8	40.4	56.1	33.5	45.7	66.1	92.5	56.7	76.8	106	118	170	237	148	204	283
3000	14.3	18.3	25.1	35.2	48.1	29.2	39.6	57.5	80.7	48.9	66.4	92.0	109	153	214	140	193	269
3250	12.5	16.1	22.1	31.1	42.0	25.5	34.8	50.6	71.2	42.7	58.1	80.6	98.1	136	193	131	182	258
3500	11.1	14.3	19.6	27.3	37.0	22.6	30.8	45.0	63.5	37.7	51.4	71.3	87.5	121	172	122	171	245
3750	9.88	12.8	17.6	24.2	33.0	20.2	27.6	40.4	57.2	33.6	45.9	63.7	78.0	108	155	113	159	229
4000	8.90	11.5	15.9	21.7	29.7	18.2	24.9	36.5	51.8	30.2	41.2	57.3	70.1	97.7	140	104	148	208
4250	8.07	10.5	14.4	19.6	26.9	16.5	22.7	33.2	47.3	27.3	37.3	51.8	63.5	88.7	127	95.3	138	188
4500	<b>7.37</b>	<b>9.57</b>	<b>13.1</b>	<b>17.8</b>	<b>24.6</b>	15.0	20.7	30.5	43.4	24.8	34.0	47.1	57.9	81.1	116	88.0	126	172
4750	<b>6.76</b>	<b>8.79</b>	<b>11.9</b>	<b>16.3</b>	<b>22.6</b>	<b>13.8</b>	<b>19.1</b>	<b>28.0</b>	<b>39.8</b>	22.7	31.1	43.1	53.1	74.6	106	81.5	115	157
5000	<b>6.23</b>	<b>8.11</b>	<b>10.9</b>	<b>15.0</b>	<b>20.4</b>	<b>12.7</b>	<b>17.6</b>	<b>26.0</b>	<b>36.5</b>	20.9	28.6	39.6	48.9	68.9	97.4	75.8	106	145
5250	<b>5.77</b>	<b>7.52</b>	<b>10.0</b>	<b>13.8</b>	<b>18.5</b>	<b>11.8</b>	<b>16.3</b>	<b>24.1</b>	<b>33.7</b>	19.3	26.4	36.5	45.3	63.9	89.8	70.7	97.5	134
5500	<b>5.37</b>	<b>6.93</b>	<b>9.27</b>	<b>12.8</b>	<b>16.9</b>	<b>10.9</b>	<b>15.2</b>	<b>22.5</b>	<b>31.2</b>	17.8	24.4	33.7	42.1	59.5	83.1	65.4	90.4	125
5750	<b>5.01</b>	<b>6.41</b>	<b>8.61</b>	<b>12.0</b>	<b>15.4</b>	<b>10.2</b>	<b>14.2</b>	<b>21.1</b>	<b>29.0</b>	16.6	22.7	31.2	39.2	55.3	77.2	60.7	84.2	116
6000	<b>4.68</b>	<b>5.96</b>	<b>8.03</b>	<b>11.2</b>	<b>14.2</b>	<b>9.56</b>	<b>13.4</b>	<b>19.6</b>	<b>26.6</b>	<b>15.5</b>	<b>21.2</b>	<b>29.0</b>	36.7	51.6	71.9	56.6	78.6	109
6250	<b>4.40</b>	<b>5.56</b>	<b>7.51</b>	<b>10.4</b>	<b>13.1</b>	<b>8.98</b>	<b>12.6</b>	<b>18.3</b>	<b>24.5</b>	<b>14.5</b>	<b>19.8</b>	<b>26.7</b>	34.5	48.2	67.1	53.0	73.7	102
6500	<b>4.11</b>	<b>5.20</b>	<b>7.05</b>	<b>9.59</b>	<b>12.1</b>	<b>8.45</b>	<b>11.9</b>	<b>17.2</b>	<b>22.7</b>	<b>13.6</b>	<b>18.5</b>	<b>24.7</b>	32.5	45.2	62.8	49.7	69.2	96.2
6750	<b>3.85</b>	<b>4.88</b>	<b>6.64</b>	<b>8.89</b>	<b>11.2</b>	<b>7.98</b>	<b>11.2</b>	<b>16.2</b>	<b>21.0</b>	<b>12.7</b>	<b>17.4</b>	<b>22.9</b>	30.7	42.4	58.9	46.7	65.2	90.8
7000	<b>3.62</b>	<b>4.60</b>	<b>6.27</b>	<b>8.27</b>	<b>10.4</b>	<b>7.56</b>	<b>10.6</b>	<b>15.2</b>	<b>19.5</b>	<b>12.0</b>	<b>16.3</b>	<b>21.3</b>	<b>29.0</b>	<b>39.9</b>	<b>55.4</b>	44.0	61.6	85.9
	EZ150-10	EZ150-12	EZ150-15	EZ150-19	EZ150-24	EZ200-12	EZ200-15	EZ200-19	EZ200-24	EZ250-15	EZ250-19	EZ250-24	EZ300-19	EZ300-24	EZ300-30	EZ350-19	EZ350-24	EZ350-30
1500	38.6	50.2	67.7	91.9	125	60.7	79.6	125	171	82.6	119	173	148	207	320	176	244	339
1750	31.1	40.9	54.9	74.6	102	53.8	71.1	109	148	74.3	109	151	139	194	299	170	235	326
2000	25.4	32.8	43.7	59.5	80.9	46.3	63.9	92.6	126	65.6	94.3	129	130	183	272	163	225	312
2250	21.2	26.7	35.7	48.6	65.9	39.0	53.8	76.8	105	57.4	78.5	108	119	173	244	155	214	296
2500	17.6	22.3	29.8	40.5	53.8	33.4	44.9	64.3	87.6	48.0	65.8	90.5	109	156	217	147	203	280
2750	15.0	19.0	25.3	34.3	44.4	28.5	38.2	54.7	74.6	40.9	56.2	77.3	99	136	190	138	190	266
3000	12.9	16.3	21.8	29.3	37.3	24.6	33.0	47.2	64.3	35.3	48.7	67.0	86.4	118	165	128	178	253
3250	11.2	14.2	19.0	25.0	31.8	21.4	28.8	41.3	56.1	30.9	42.6	58.8	75.4	103	144	118	165	236
3500	9.91	12.6	16.7	21.6	27.4	18.9	25.4	36.4	49.4	27.3	37.8	52.0	66.5	91.0	128	108	152	213
3750	8.81	11.1	14.8	18.8	23.9	16.8	22.6	32.4	43.9	24.4	33.7	46.4	59.2	81.2	114	98	141	189
4000	<b>7.89</b>	<b>10.0</b>	<b>13.0</b>	<b>16.5</b>	<b>21.0</b>	15.1	20.3	29.0	38.8	21.9	30.3	41.7	53.2	72.9	102	89	126	170
4250	<b>7.11</b>	<b>8.98</b>	<b>11.5</b>	<b>14.6</b>	<b>18.6</b>	<b>13.6</b>	<b>18.3</b>	<b>26.2</b>	<b>34.3</b>	19.9	27.4	37.6	48.1	66.0	92.4	82	114	153
4500	<b>6.45</b>	<b>8.13</b>	<b>10.3</b>	<b>13.0</b>	<b>16.6</b>	<b>12.4</b>	<b>16.7</b>	<b>23.7</b>	<b>30.6</b>	<b>18.1</b>	<b>25.0</b>	<b>34.2</b>	43.7	60.0	84.0	75	103	139
4750	<b>5.87</b>	<b>7.38</b>	<b>9.23</b>	<b>11.71</b>	<b>14.9</b>	<b>11.3</b>	<b>15.2</b>	<b>21.6</b>	<b>27.5</b>	<b>16.5</b>	<b>22.8</b>	<b>31.2</b>	39.9	54.9	76.8	69.3	94.3	127
5000	<b>5.37</b>	<b>6.66</b>	<b>8.33</b>	<b>10.56</b>	<b>13.4</b>	<b>10.4</b>	<b>13.9</b>	<b>19.6</b>	<b>24.8</b>	<b>15.2</b>	<b>21.0</b>	<b>28.4</b>	36.7	50.4	70.5	63.5	86.5	117
5250	<b>4.94</b>	<b>6.04</b>	<b>7.56</b>	<b>9.58</b>	<b>12.2</b>	<b>9.55</b>	<b>12.8</b>	<b>17.8</b>	<b>22.5</b>	<b>14.0</b>	<b>19.3</b>	<b>25.8</b>	33.8	46.5	64.9	58.4	79.7	108
5500	<b>4.55</b>	<b>5.50</b>	<b>6.89</b>	<b>8.73</b>	<b>11.1</b>	<b>8.83</b>	<b>11.8</b>	<b>16.2</b>	<b>20.5</b>	<b>13.0</b>	<b>17.9</b>	<b>23.5</b>	31.3	43.1	60.0	54.0	73.7	100
5750	<b>4.20</b>	<b>5.04</b>	<b>6.30</b>	<b>7.99</b>	<b>10.2</b>	<b>8.20</b>	<b>11.0</b>	<b>14.8</b>	<b>18.8</b>	<b>12.1</b>	<b>16.6</b>	<b>21.5</b>	29.1	40.0	55.6	50.1	68.5	92.5
6000	<b>3.85</b>	<b>4.63</b>	<b>5.79</b>	<b>7.34</b>	<b>9.34</b>	<b>7.63</b>	<b>10.2</b>	<b>13.6</b>	<b>17.2</b>	<b>11.3</b>	<b>15.4</b>	<b>19.7</b>	<b>27.1</b>	<b>37.3</b>	<b>51.7</b>	46.6	63.8	86.2
6250	<b>3.55</b>	<b>4.26</b>	<b>5.33</b>	<b>6.76</b>	<b>8.60</b>	<b>7.12</b>	<b>9.43</b>	<b>12.6</b>	<b>15.9</b>	<b>10.5</b>	<b>14.4</b>	<b>18.2</b>	<b>25.4</b>	<b>34.8</b>	<b>48.0</b>	43.5	59.6	80.5
6500	<b>3.28</b>	<b>3.94</b>	<b>4.93</b>	<b>6.25</b>	<b>7.96</b>	<b>6.66</b>	<b>8.72</b>	<b>11.6</b>	<b>14.7</b>	<b>9.86</b>	<b>13.3</b>	<b>16.8</b>	<b>23.8</b>	<b>32.6</b>	<b>44.4</b>	40.8	55.8	75.4
6750	<b>3.05</b>	<b>3.65</b>	<b>4.57</b>	<b>5.80</b>	<b>7.38</b>	<b>6.24</b>	<b>8.08</b>	<b>10.8</b>	<b>13.6</b>	<b>9.26</b>	<b>12.3</b>	<b>15.6</b>	<b>22.3</b>	<b>30.6</b>	<b>41.2</b>	38.3	52.4	70.8
7000	<b>2.83</b>	<b>3.40</b>	<b>4.25</b>	<b>5.39</b>	<b>6.86</b>	<b>5.87</b>	<b>7.52</b>	<b>10.0</b>	<b>12.7</b>	<b>8.71</b>	<b>11.5</b>	<b>14.5</b>	<b>21.0</b>	<b>28.8</b>	<b>38.3</b>	<b>36.0</b>	<b>49.3</b>	<b>66.6</b>

NOTES: TABLES 20 to 22.

1. The numbers in **bold italics** are limited by the slenderness ratio in clause 3.4.1 of AS/NZS4600:2005

2. Braces are assumed to provide torsional restraint ( e.g. Stramit® Bridging ).

3. Use unbraced data ( Table 19 ) if bracing does not provide full torsional restraint.

Outside **Stramit® Bridging** recommendations.

**Table 21**

<b>STRAMIT EXACTA® PURLINS – DESIGN MEMBER CAPACITIES FOR AXIAL COMPRESSION Two intermediate braces - <math>\phi_c N_c</math> (kN)</b>																		
Unbraced Length (mm)	Stramit® Exacta® Purlin/Girt Size																	
	EC150-10	EC150-12	EC150-15	EC150-19	EC150-24	EC200-12	EC200-15	EC200-19	EC200-24	EC250-15	EC250-19	EC250-24	EC300-19	EC300-24	EC300-30	EC350-19	EC350-24	EC350-30
1500	34.4	45.2	61.0	83.2	114	59.3	78.3	123	169	89.2	125	189	156	216	335	177	245	340
1750	27.4	35.8	47.9	65.6	89.7	52.4	69.9	108	147	82.2	118	170	148	204	312	171	236	328
2000	22.4	28.5	38.3	52.5	71.8	45.4	62.5	91.1	125	74.8	109	151	139	193	288	164	226	314
2250	18.4	23.3	31.4	43.2	58.5	38.7	53.5	75.7	104	67.2	95.3	132	130	185	263	156	216	299
2500	15.4	19.5	26.4	36.2	48.0	33.1	44.8	63.5	87.6	59.6	81.6	114	120	173	238	148	205	283
2750	13.1	16.7	22.5	30.9	40.1	28.3	38.2	54.3	75.0	50.8	69.9	98.0	110	154	214	140	193	269
3000	11.3	14.4	19.5	26.3	34.1	24.5	33.1	47.1	65.2	44.0	60.7	85.4	98.5	136	190	130	181	256
3250	9.88	12.6	17.1	22.6	29.5	21.4	29.0	41.3	57.3	38.6	53.4	75.4	86.9	119	167	120	168	241
3500	8.74	11.2	15.1	19.7	25.7	18.9	25.7	36.7	50.8	34.2	47.5	67.2	76.8	106	148	110	156	221
3750	7.79	10.0	13.3	17.3	22.7	16.9	23.0	32.8	45.4	30.6	42.6	60.4	68.5	94.6	133	100	145	198
4000	7.00	8.96	11.8	15.4	20.2	15.2	20.7	29.6	40.8	27.6	38.5	54.7	61.5	85.3	120	91.7	131	178
4250	6.34	8.10	10.5	13.8	18.1	13.8	18.8	26.8	36.4	25.0	35.1	49.9	55.7	77.4	109	84.2	119	161
4500	<b>5.76</b>	<b>7.35</b>	<b>9.44</b>	<b>12.4</b>	<b>16.4</b>	12.5	17.1	24.5	32.8	22.9	32.1	45.8	50.8	70.7	99.7	77.6	108	147
4750	<b>5.27</b>	<b>6.64</b>	<b>8.55</b>	<b>11.3</b>	<b>14.9</b>	<b>11.5</b>	<b>15.7</b>	<b>22.4</b>	<b>29.7</b>	21.0	29.5	42.2	46.5	64.9	91.7	71.8	98.6	134
5000	<b>4.84</b>	<b>6.03</b>	<b>7.78</b>	<b>10.3</b>	<b>13.6</b>	<b>10.6</b>	<b>14.5</b>	<b>20.6</b>	<b>27.1</b>	19.4	27.3	39.1	42.8	59.9	84.6	66.0	90.6	124
	EZ150-10	EZ150-12	EZ150-15	EZ150-19	EZ150-24	EZ200-12	EZ200-15	EZ200-19	EZ200-24	EZ250-15	EZ250-19	EZ250-24	EZ300-19	EZ300-24	EZ300-30	EZ350-19	EZ350-24	EZ350-30
1500	38.6	50.2	67.7	91.9	125	60.7	79.6	125	171	82.6	119	173	148	207	320	176	244	339
1750	31.1	40.9	54.9	74.6	102	53.8	71.1	109	148	74.3	109	151	139	194	299	170	235	326
2000	25.4	32.8	43.7	59.5	80.9	46.3	63.9	92.6	126	65.6	94	129	130	183	272	163	225	312
2250	21.2	26.7	35.7	48.6	65.9	39.0	53.8	76.8	105	57.4	78.5	108	119	173	244	155	214	296
2500	17.6	22.3	29.8	40.5	53.8	33.4	44.9	64.3	87.6	48.0	65.8	90.5	109	156	217	147	203	280
2750	15.0	19.0	25.3	34.3	44.4	28.5	38.2	54.7	74.6	40.9	56.2	77.3	98.6	136	190	138	190	266
3000	12.9	16.3	21.8	29.3	37.3	24.6	33.0	47.2	64.3	35.3	48.7	67.0	86.4	118	165	128	178	253
3250	11.2	14.2	19.0	25.0	31.8	21.4	28.8	41.3	56.1	30.9	42.6	58.8	75.4	103	144	118	165	236
3500	9.91	12.6	16.7	21.6	27.4	18.9	25.4	36.4	49.4	27.3	37.8	52.0	66.5	91.0	128	108	152	213
3750	8.81	11.1	14.8	18.8	23.9	16.8	22.6	32.4	43.9	24.4	33.7	46.4	59.2	81.2	114	97.7	141	189
4000	<b>7.89</b>	<b>10.0</b>	<b>13.0</b>	<b>16.5</b>	<b>21.0</b>	15.1	20.3	29.0	38.8	21.9	30.3	41.7	53.2	72.9	102	89.2	126	170
4250	<b>7.11</b>	<b>8.98</b>	<b>11.5</b>	<b>14.6</b>	<b>18.6</b>	<b>13.6</b>	<b>18.3</b>	<b>26.2</b>	<b>34.3</b>	19.9	27.4	37.6	48.1	66.0	92.4	81.7	114	153
4500	<b>6.45</b>	<b>8.13</b>	<b>10.3</b>	<b>13.0</b>	<b>16.6</b>	<b>12.4</b>	<b>16.7</b>	<b>23.7</b>	<b>30.6</b>	<b>18.1</b>	<b>25.0</b>	<b>34.2</b>	43.7	60.0	84.0	75.2	103	139
4750	<b>5.87</b>	<b>7.38</b>	<b>9.23</b>	<b>11.7</b>	<b>14.9</b>	<b>11.3</b>	<b>15.2</b>	<b>21.6</b>	<b>27.5</b>	<b>16.5</b>	<b>22.8</b>	<b>31.2</b>	39.9	54.9	76.8	69.3	94.3	127
5000	<b>5.37</b>	<b>6.66</b>	<b>8.33</b>	<b>10.6</b>	<b>13.4</b>	<b>10.4</b>	<b>13.9</b>	<b>19.6</b>	<b>24.8</b>	<b>15.2</b>	<b>21.0</b>	<b>28.4</b>	36.7	50.4	70.5	63.5	86.5	117



NOTES: TABLES 20 to 22.

1. The numbers in **bold italics** are limited by the slenderness ratio in clause 3.4.1 of AS/NZS4600:2005

2. Braces are assumed to provide torsional restraint ( e.g. Stramit® Bridging ).

3. Use unbraced data ( Table 19 ) if bracing does not provide full torsional restraint.

Outside **Stramit® Bridging** recommendations.

**Table 22**

<b>STRAMIT EXACTA® PURLINS – DESIGN MEMBER CAPACITIES FOR AXIAL COMPRESSION Three intermediate braces - <math>\phi_c N_c</math> (kN)</b>																		
Unbraced Length (mm)	Stramit® Exacta® Purlin/Girt Size																	
	EC150-10	EC150-12	EC150-15	EC150-19	EC150-24	EC200-12	EC200-15	EC200-19	EC200-24	EC250-15	EC250-19	EC250-24	EC300-19	EC300-24	EC300-30	EC350-19	EC350-24	EC350-30
1500	30.2	39.7	53.2	72.5	99	56.1	74.3	116	157	86.9	122	182	153	211	326	174	241	335
1750	24.0	30.6	41.0	55.9	75.9	48.6	65.1	98	133	79.2	115	162	144	199	301	167	231	321
2000	19.3	24.4	32.7	44.6	60.2	41.1	57.2	80.2	110	71.2	103	141	134	189	274	160	221	306
2250	15.8	20.0	26.8	36.6	48.0	34.6	46.9	65.8	90	63.9	87.7	122	124	179	247	151	209	289
2500	13.2	16.7	22.5	30.6	39.2	29.2	39.3	55.3	75.8	54.1	74.0	103	113	160	220	143	196	272
2750	11.2	14.3	19.1	25.5	32.7	24.9	33.5	47.2	64.8	46.1	63.3	88.3	102	141	194	133	183	259
3000	9.7	12.3	16.5	21.5	27.7	21.5	29.0	40.9	56.1	39.9	55.0	76.9	89.3	122	169	122	170	243
3250	8.47	10.8	14.4	18.5	23.8	18.8	25.4	35.8	49.2	35.0	48.3	67.8	78.0	107	149	111	156	221
3500	7.48	9.5	12.5	16.1	20.7	16.6	22.5	31.7	43.5	31.0	42.9	60.3	68.9	95	132	100	144	196
3750	6.66	8.5	10.9	14.1	18.2	14.8	20.1	28.3	38.3	27.7	38.5	54.1	61.5	84.7	118	91	130	175
4000	5.98	7.59	9.6	12.5	16.2	13.3	18.1	25.5	33.9	25.0	34.8	48.9	55.2	76.3	106	83.2	117	157
4250	5.40	6.76	8.6	11.1	14.4	12.1	16.4	23.0	30.2	22.7	31.6	44.5	50.0	69.2	97	76.2	105	143
4500	<b>4.90</b>	<b>6.06</b>	<b>7.72</b>	<b>10.0</b>	<b>13.0</b>	11.0	14.9	21.0	27.1	20.7	28.9	40.7	45.6	63.2	88.1	70.1	96	130
4750	<b>4.47</b>	<b>5.46</b>	<b>6.97</b>	<b>9.1</b>	<b>11.8</b>	<b>10.1</b>	<b>13.7</b>	<b>19.0</b>	<b>24.5</b>	19.0	26.5	37.4	41.7	57.9	80.9	64.0	87.5	119
5000	<b>4.07</b>	<b>4.95</b>	<b>6.33</b>	<b>8.2</b>	<b>10.7</b>	<b>9.2</b>	<b>12.6</b>	<b>17.2</b>	<b>22.3</b>	17.5	24.5	34.5	38.4	53.4	74.5	58.7	80.4	109
	EZ150-10	EZ150-12	EZ150-15	EZ150-19	EZ150-24	EZ200-12	EZ200-15	EZ200-19	EZ200-24	EZ250-15	EZ250-19	EZ250-24	EZ300-19	EZ300-24	EZ300-30	EZ350-19	EZ350-24	EZ350-30
1500	38.2	49.6	66.7	90.1	122	60.7	79.6	125	171	82.6	119	173	148	207	320	176	244	339
1750	30.7	40.3	53.8	72.6	97.7	53.8	71.1	109	148	74.3	109	151	139	194	299	170	235	326
2000	25.2	32.2	42.8	57.7	77.5	46.3	63.9	92.6	126	65.6	94.3	129	130	183	272	163	225	312
2250	20.9	26.3	35.0	47.2	63.1	39.0	53.8	76.8	105	57.4	78.5	108	119	173	244	155	214	296
2500	17.4	22.0	29.2	39.3	51.2	33.4	44.9	64.3	87.6	48.0	65.8	90.5	109	156	217	147	203	280
2750	14.8	18.7	24.8	33.3	42.3	28.5	38.2	54.7	74.6	40.9	56.2	77.3	98.6	136	190	138	190	266
3000	12.7	16.1	21.4	28.3	35.5	24.6	33.0	47.2	64.3	35.3	48.7	67.0	86.4	118	165	128	178	253
3250	11.1	14.0	18.6	24.2	30.3	21.4	28.8	41.3	56.1	30.9	42.6	58.8	75.4	103	144	118	165	236
3500	9.8	12.3	16.3	20.8	26.1	18.9	25.4	36.4	49.4	27.3	37.8	52.0	66.5	91.0	128	108	152	213
3750	8.7	11.0	14.4	18.1	22.7	16.8	22.6	32.4	43.9	24.4	33.7	46.4	59.2	81.2	114	97.7	141	189
4000	<b>7.8</b>	<b>9.8</b>	<b>12.7</b>	<b>15.9</b>	<b>20.0</b>	15.1	20.3	29.0	38.8	21.9	30.3	41.7	53.2	72.9	102	89.2	126	170
4250	<b>7.0</b>	<b>8.8</b>	<b>11.2</b>	<b>14.1</b>	<b>17.7</b>	<b>13.6</b>	<b>18.3</b>	<b>26.2</b>	<b>34.3</b>	19.9	27.4	37.6	48.1	66.0	92.4	81.7	114	153
4500	<b>6.4</b>	<b>8.0</b>	<b>10.0</b>	<b>12.6</b>	<b>15.8</b>	<b>12.4</b>	<b>16.7</b>	<b>23.7</b>	<b>30.6</b>	<b>18.1</b>	<b>25.0</b>	<b>34.2</b>	43.7	60.0	84.0	75.2	103	139
4750	<b>5.80</b>	<b>7.2</b>	<b>9.0</b>	<b>11.3</b>	<b>14.2</b>	<b>11.3</b>	<b>15.2</b>	<b>21.6</b>	<b>27.5</b>	<b>16.5</b>	<b>22.8</b>	<b>31.2</b>	39.9	54.9	76.8	69.3	94.3	127
5000	<b>5.31</b>	<b>6.5</b>	<b>8.1</b>	<b>10.2</b>	<b>12.8</b>	<b>10.4</b>	<b>13.9</b>	<b>19.6</b>	<b>24.8</b>	<b>15.2</b>	<b>21.0</b>	<b>28.4</b>	36.7	50.4	70.5	63.5	86.5	117

## Design Example 2

### Configuration

Consider the same span and final bridging configuration as Design Example 1, but with a different loading condition (a lower outward wind uplift, applied in combination with an axial compression load).

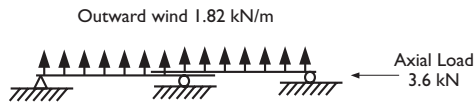

The bending moments are proportionately lower than those in Design Example 1.

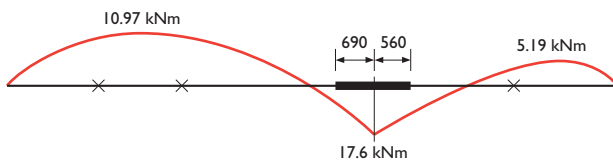

To check combined axial and bending loads, divide the span into unbraced lengths.

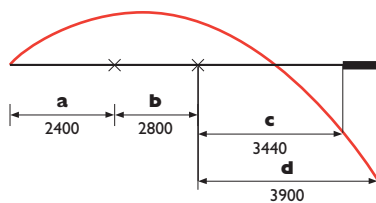

### Validity

First check that the loading combination meets the rules for the simplified equations applied to the EZ250-19 section previously established in Example 1.

$\frac{N^*}{\phi_c N_c}$  must equal 0.15 or less.

Use Table 21 to obtain  $\phi_c N_c$  as this span has two intermediate braces (bridging). For the longest unbraced length of 3900,  $\phi_c N_c$  is 28.64 kN for an EZ250-19.

In this case  $\frac{3.6}{28.64} = 0.125$  which is OK

### Unbraced Length a

By interpolation from Table 15,  $\phi_b M_b$  for an EZ250-19 is 23.2 kNm. From Table 21,  $\phi_c N_c$  for a EZ250-19 is 81.6 kN.

Using the formula on page 18

$$\frac{3.6}{81.6} + \frac{9.47}{23.2} = 0.45 < 1 \text{ OK}$$

### Unbraced Length b

This time use Table 16 to find  $\phi_b M_b$  which for EZ250-19 is 14.0 kNm. Still use Table 21 for  $\phi_c N_c$  which is now 48.7 kN at this unbraced length.

Now  $\frac{3.6}{48.7} + \frac{10.97}{14.0} = 0.86 < 1 \text{ OK}$

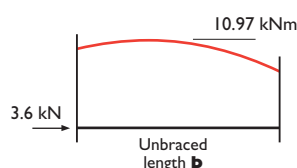
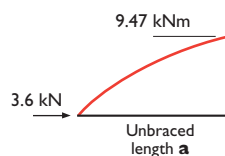

### Unbraced Length c

As this case involves two different moment segment types, the extreme values  $\phi_b M_b$  must be established.

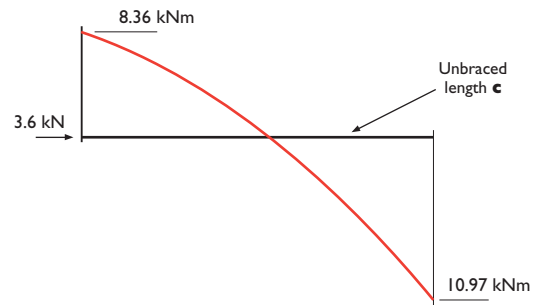

Check Tables 14 and 16, calling the span 3440 the unbraced length 'c' for simplicity. From Table 15 for Type 1 segments, for an EZ250-19  $\phi_b M_b$  is 10.9 kNm.

Still using Table 21,  $\phi_c N_c$  is 38.9 kN.

$$\frac{3.6}{38.9} + \frac{8.36}{10.9} = 0.86 < 1 \text{ OK}$$

For the second part, using Table 17 (Type 3 segments),  $\phi_b M_b$  for EZ250-19 is 12.2 kNm

Checking  $\frac{3.6}{38.9} + \frac{10.97}{12.2} = 0.991 < 1 \text{ OK}$

### Unbraced Length d

Again, this case requires checking at each end for criticality. For the left end  $\phi_b M_b$  will be less as the unbraced length is now 4000.

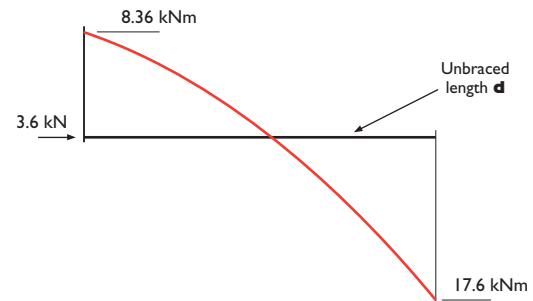

Still using Table 15, this is 10.8 kNm.  $\phi_c N_c$  from Table 21 gives 31.66 kN.

Checking the left end:  $\frac{3.6}{31.66} + \frac{8.36}{10.8} = 0.89 < 1 \text{ OK}$

For the right end,  $\phi_b M_b$  from Table 17 is 15.9 kNm.

However, as both axial and bending actions are shared between two purlins within the lap, the capacity can be doubled. (Note that if the section were of different thickness the capacities for each section could be added).

Checking the right end:  $\frac{3.6}{2 \times 31.66} + \frac{8.36}{2 \times 15.9} = 0.61 < 1 \text{ OK}$

## Procurement

### Availability

**Stramit Exacta® C&Z Purlins** are available in all regions of Australia.

### Prices

Prices of **Stramit Exacta® C&Z Purlins and Girts**, **Stramit® Bridging** and their accessories can be obtained from your nearest Stramit location or distributor of Stramit products.

### Lengths

**Stramit Exacta® C&Z Purlins and Girts** are supplied cut-to-length. If you are designing or transporting long products ensure that the length is within the limit of the local Transport Authority regulations. All sections are custom-cut to length from 0.6m to 12.0m. For longer lengths, contact your Stramit representative to determine special transport arrangements. Lengths less than 1.5m may be supplied “sausage” style in a continuous run approximately 5m long with only a small uncut tag connecting the purlin. Simply break off individual purlins on site. Although supplied in a string, each purlin has individual marking labels.

### Accessories

**Stramit Exacta® C&Z Purlins and Girts** use exactly the same comprehensive range of components as standard **Stramit® Purlins**. Accessories include turnbuckles, clamp plates, extended angle brackets and slotted channel. **Stramit® Bridging** in any combination of channel, locator end, lock end and bolted end can be supplied in a pre-assembled form. These are also available in a bolted form (hinged) for use on curved roofs and at expansion joints.

### Orders

**Stramit Exacta® C&Z Purlins and Girts, Stramit® Bridging** and accessories can be ordered directly from your nearest Stramit location. Exact details of lengths, hole positions and section sizes are required. Ask at your nearest Stramit location for order pad/detailing sheets.

### Lead Times

Please talk to your nearest Stramit branch for current lead times on **Stramit Exacta® C&Z Purlins** manufacture and delivery.

## Installation

Always follow the applicable OH&S regulations for your state.

### Good Practice

Stramit recommends that good trade practice be followed when using these products, such as found in Australian Standards AS3828 and HB39.

### Walking

**Stramit Exacta® C&Z Purlins, Girts and Bridging** are not designed to be walked on. Residual oil may be present on these components from manufacturing. Do not walk on purlins or bridging.

### Bolts

Always use the correct size and grade of bolts. Ensure that all bolts are securely tightened.

### Laps

Purlin laps must be bolted in the top web hole and the lower flange holes at both ends of the lap as shown below. Bolting only in the web of lapped purlins does not provide full structural continuity and excessive loads could be placed on to roofing screws that penetrate both purlins within a lapped region.

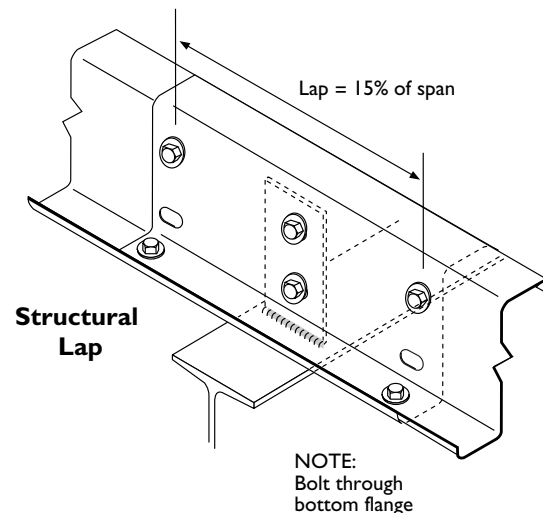

### Endlapping with Standard Purlins

**Stramit Exacta® C&Z Purlins** have different web and flange sizes to standard purlins and will therefore not end lap.

### Fly Bracing

If the lower web hole in a lap is used for attaching fly bracing ensure that an additional bolt is used.

## Bridging

**Stramit® Bridging** can be installed either up or down the roof slope, but cannot be mixed within a bridging run. However, as the starting and finishing components will be different, the direction of fixing must be established at the design/procurement phase.

Girt bridging must not exceed its compressive capacity. Where more than one row is to be installed always complete the bridging for each girt before commencing on the next (i.e. do not complete one row of bridging before starting the next).

## Welding

Stramit does not recommend the welding or hot cutting of purlins, girts or bridging. The heat produced in welding will affect the material properties of the high-yield strength cold-formed steel used by Stramit in its purlins. In many instances considerable stress concentrations are likely to arise, even with good quality welding. In addition, welding will locally remove the protective coating, leading to a potential reduction in durability.

## **Additional Information**

### Further Information

As well as our standard range of Technical Manuals, Installation Leaflets, Case Studies and other promotional literature Stramit has a series of Guides to aid design.

These include:

- Concealed Fixed Decking
- Roof Slope Guide
- Foot Traffic Guide
- Roof System Selection Guide
- Bullnosing, Curving and Crimping
- Acoustic Panels
- Cyclonic Areas
- Spring Curving Guide

Please contact your nearest Stramit Building Products location for any of these guides, or other literature.

### Other Products

Stramit offers a wide range of building products, including:

- Formwork decking
- Roof and wall sheeting
- Lightweight structural sections
- Truss components
- Gutters and downpipes
- Fascias
- Custom flashings
- Insulating products
- Fasteners

## Girt Bridging Capacity

**Stramit® Bridging** is only designed to allow purlins and girts to resist wind loads once the sheeting has been attached. Purlins, girts and bridging should not be subjected to loading from stacked materials, even when sheeting is attached, or from lifting assemblies of framing.

Bridging used with girts may be subjected to compressive (or tensile) loading due to gravity during installation. These loads become cumulative with increasing wall height, unless a separation joint is included. The capacity of **Stramit® Boltless Bridging, Stramit® Bolted Bridging** and **Stramit® Large Series Bridging** to resist these loads is given in the **Stramit® Purlins, Girts and Bridging Technical Manual**. These capacities are based on the mass of the girts plus a 1.1kN load to allow for riggers.

WARNING – girt bridging capacity is usually limited by bridging end component strength rather than channel compression. **Stramit® Bridging** ends have been designed through testing to have a capacity substantially greater than most other bridging types. Accordingly this data must only be used for **Stramit® Bridging**.

### EX-facta™ Design Software

Stramit Building Products offers highly interactive **EX-facta™** design software for use by engineers. The key features of **EX-facta™** software are:-

- fully variable span dimensions
- variable lap lengths
- visual display of span efficiencies
- up to 10 span continuous systems
- multiple combined load cases
- variable UDL within spans
- concentrated/point loads
- variable bridging positions
- mixed bridging numbers
- cantilevers
- any combinations of the above

For a copy of the **EX-facta™** software program or for more information please contact your regional Stramit Technical Services Manager.



# Stramit EX-facta™ Design Software Example

Input of purlin type, spans, lap lengths and bridging positions

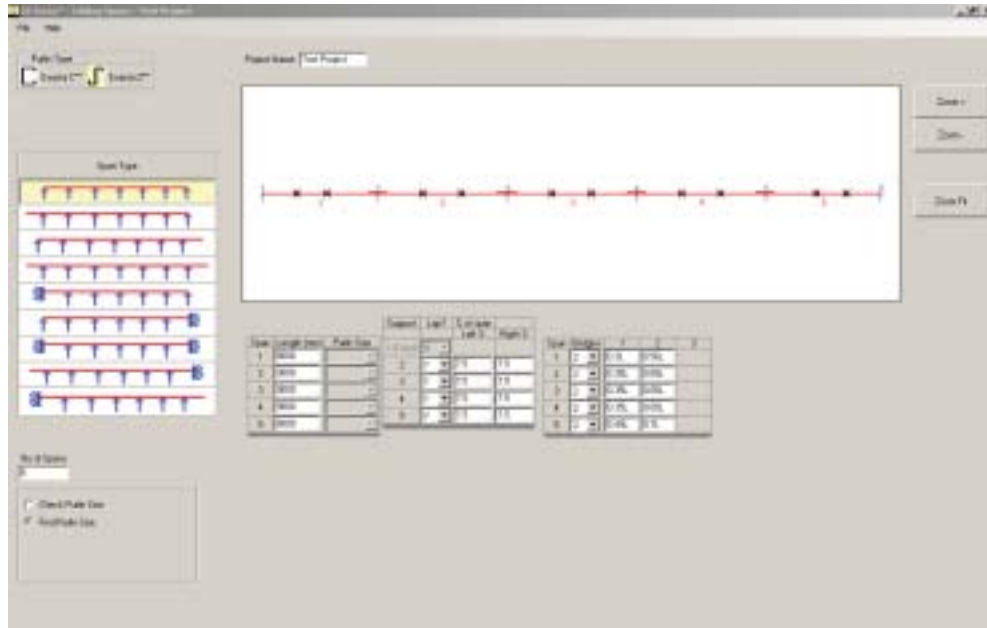

Input of primary and combined load cases with various load types

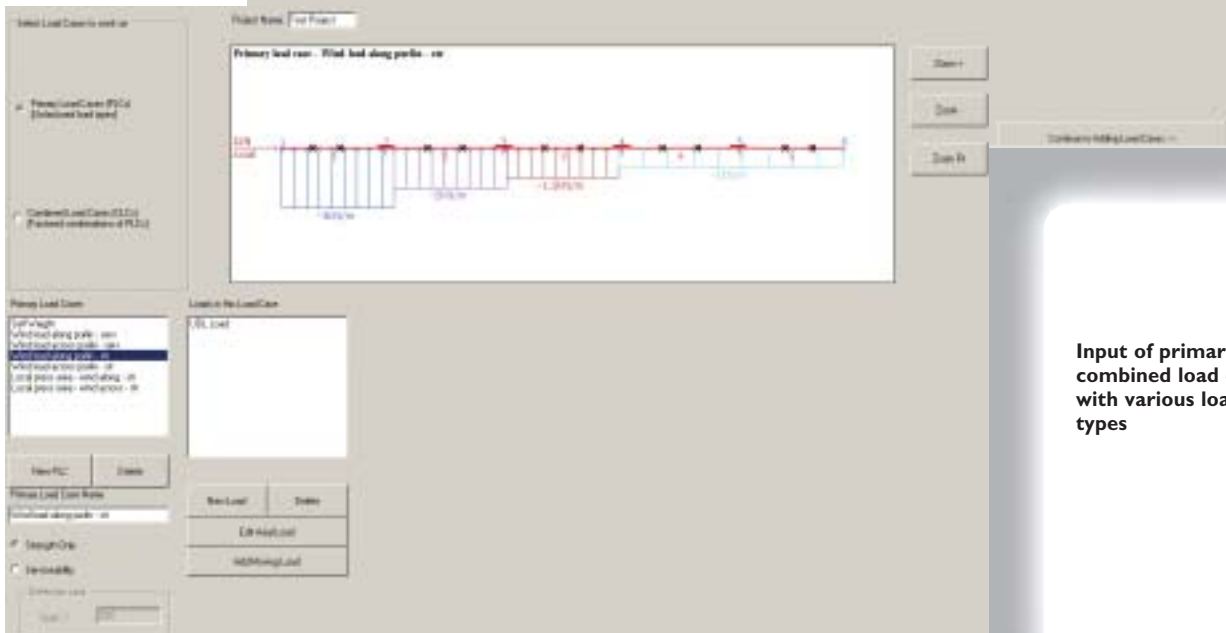

Analysis results for one load case

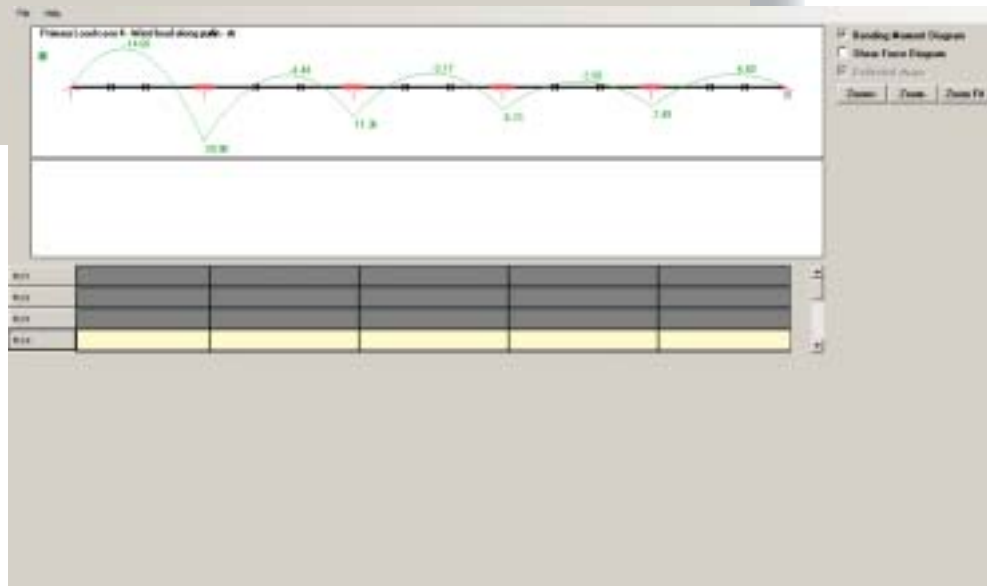

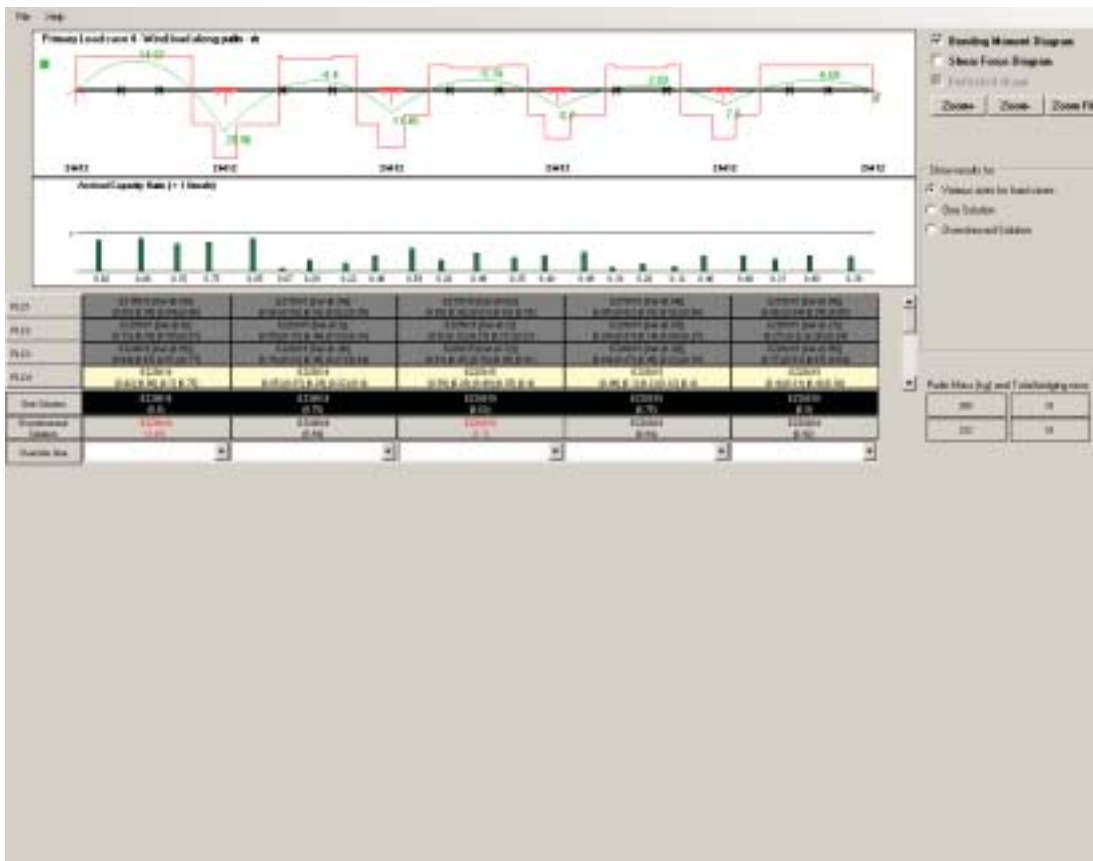

Design results showing selected purlin sizes and efficiencies

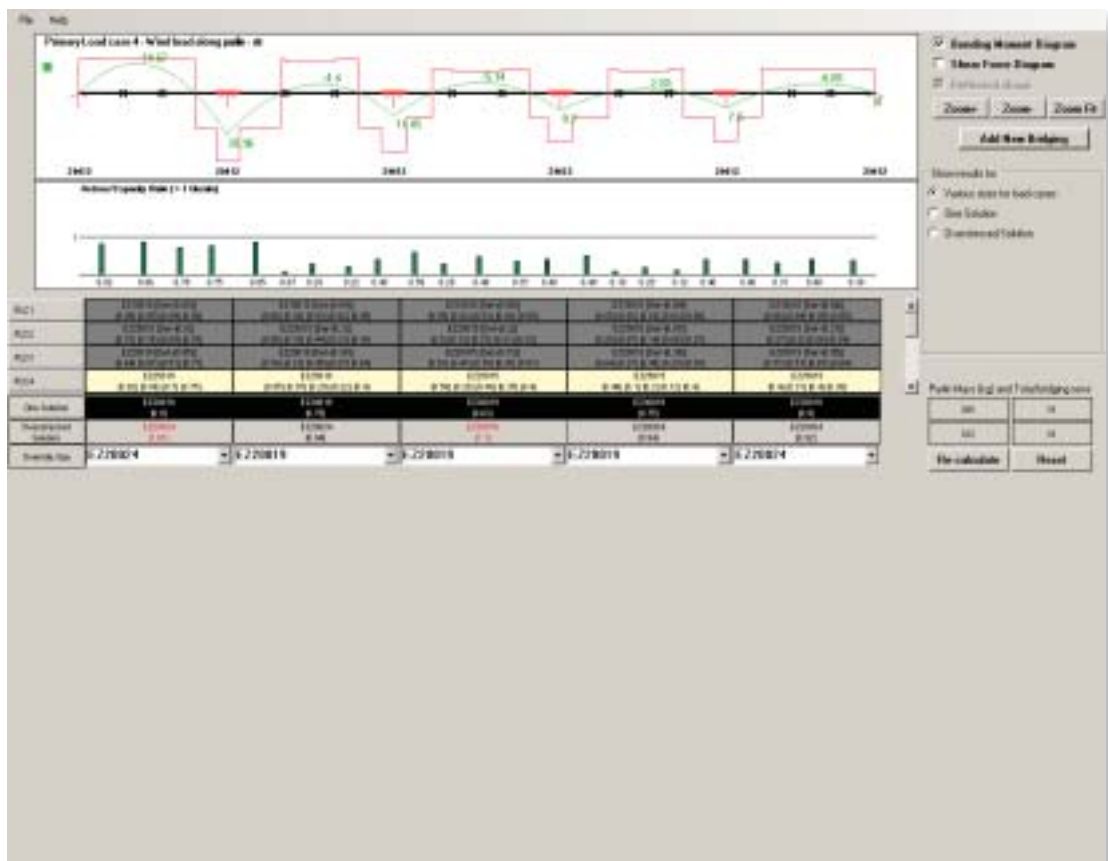

Choice of override purlin sizes for interactive design

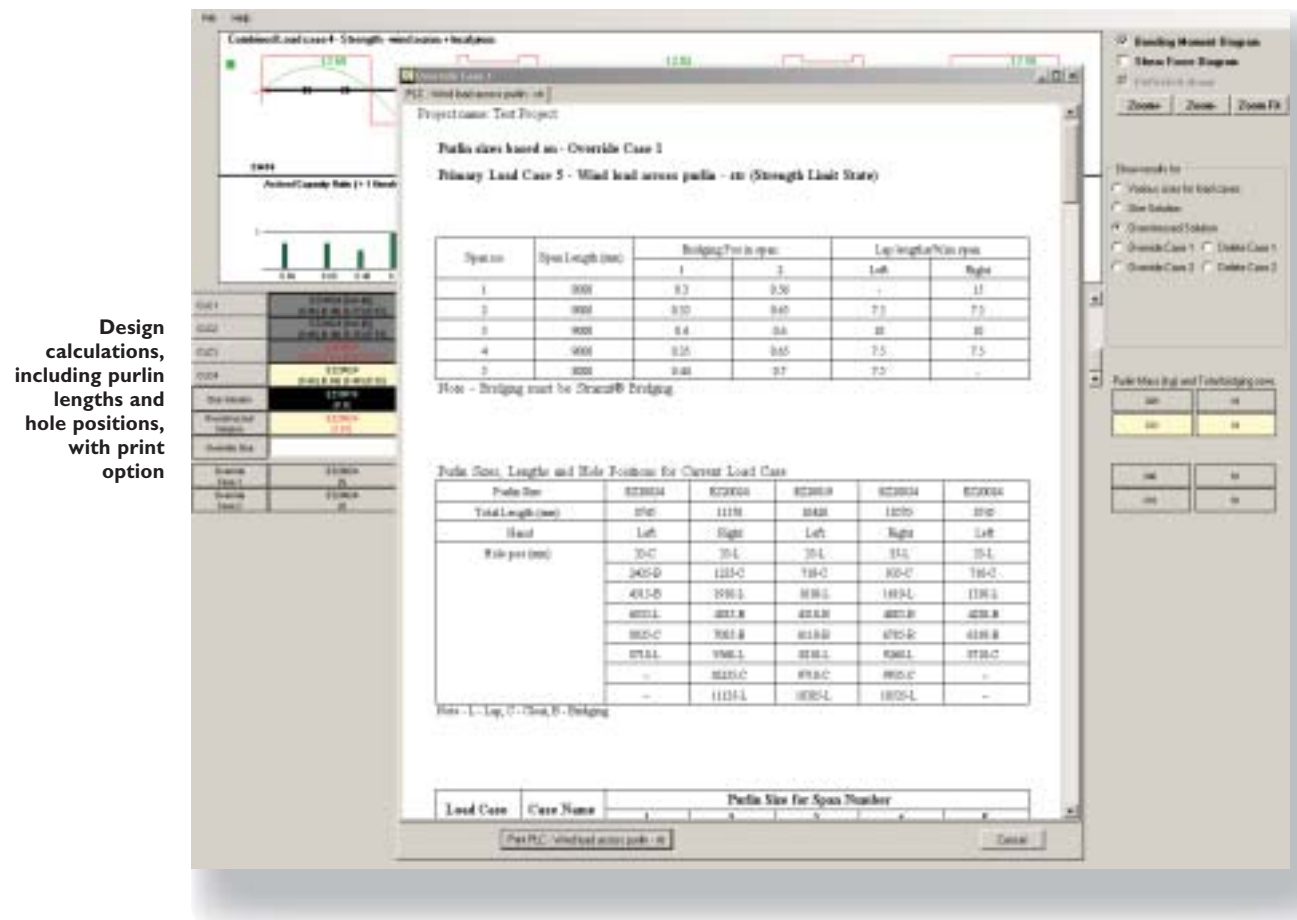



The Stramit web page can be found at:

[www.stramit.com.au](http://www.stramit.com.au)

Details of many **Stramit**® products can also be seen on the AIA site 'Product Selector' at:

[www.selector.com.au](http://www.selector.com.au)

## Building Products

		prices	availability	general	technical
contact numbers for information			products coating colours	other	advice product data
<b>SYDNEY</b> 33-83 Quarry Rd, Erskine Park NSW 2759	<b>phone</b> <b>fax</b>	<b>(02) 9834 0909</b> (02) 9834 0988		<b>(02) 9834 0900</b> (02) 9834 0988	
<b>CANBERRA</b> 4 Bass Street, Queanbeyan NSW 2620	<b>phone</b> <b>fax</b>	<b>(02) 6132 8300</b> (02) 6132 8333			
<b>COFFS HARBOUR</b> 6 Mansbridge Drive, Coffs Harbour NSW 2450	<b>phone</b> <b>fax</b>	<b>(02) 6656 3800</b> (02) 6656 3808			<b>(02) 4954 5033</b> (02) 4954 5856
<b>NEWCASTLE</b> 17 Nelson Road, Cardiff NSW 2285	<b>phone</b> <b>fax</b>	<b>(02) 4954 5033</b> (02) 4954 5856			
<b>ORANGE</b> 51 Leewood Drive, Orange NSW 2800	<b>phone</b> <b>fax</b>	<b>(02) 6361 0444</b> (02) 6361 9814			
<b>MELBOURNE</b> 2/1464 Ferntree Gully Road, Knoxfield VIC 3180	<b>phone</b> <b>fax</b>	<b>(03) 9237 6300</b> (03) 9237 6399		<b>(03) 9237 6200</b> (03) 9237 6299	
<b>ALBURY</b> 18 Ariel Drive, Albury NSW 2640	<b>phone</b> <b>fax</b>	<b>(02) 6041 7600</b> (02) 6041 7666			
<b>BENDIGO</b> Ramsay Court, Kangaroo Flat VIC 3555	<b>phone</b> <b>fax</b>	<b>(03) 5448 6400</b> (03) 5447 9677			
<b>MILDURA</b> 19 - 23 Adams Street, Mildura VIC 3500	<b>phone</b> <b>fax</b>	<b>(03) 5018 4800</b> (03) 5021 0557			
<b>HOBART</b> 57 Crooked Billett Drive, Brighton TAS 7030	<b>phone</b> <b>fax</b>	<b>(03) 6262 8888</b> (03) 6262 8812			<b>(03) 6262 8888</b> (03) 6262 8812
<b>ADELAIDE</b> 11 Stock Road, Cavan SA 5094	<b>phone</b> <b>fax</b>	<b>(08) 8262 4444</b> (08) 8262 6333			<b>(08) 8262 4444</b> (08) 8262 6333
<b>BRISBANE</b> 57-71 Platinum Street, Crestmead QLD 4132	<b>phone</b> <b>fax</b>	<b>(07) 3803 9999</b> (07) 3803 1499			
<b>TOWNSVILLE</b> 402-408 Bayswater Road, Garbutt QLD 4814	<b>phone</b> <b>fax</b>	<b>(07) 4412 3900</b> (07) 4412 3909			
<b>CAIRNS</b> Vickers Street, Edmonton QLD 4869	<b>phone</b> <b>fax</b>	<b>(07) 4034 6555</b> (07) 4034 6511			
<b>MACKAY</b> Brickworks Court, Glenella QLD 4740	<b>phone</b> <b>fax</b>	<b>(07) 4965 4000</b> (07) 4965 4012			<b>(07) 3803 9999</b> (07) 3803 1499
<b>MARYBOROUGH</b> 10 Activity St, Maryborough QLD 4650	<b>phone</b> <b>fax</b>	<b>(07) 4123 9500</b> (07) 4123 9508			
<b>ROCKHAMPTON</b> 41 Johnson St, Parkhurst QLD 4702	<b>phone</b> <b>fax</b>	<b>(07) 4921 5600</b> (07) 4921 5608			
<b>DARWIN</b> 55 Albatross Street, Winnellie NT 0820	<b>phone</b> <b>fax</b>	<b>(08) 8930 6333</b> (08) 8930 6308			
<b>PERTH</b> 605-615 Bickley Road, Maddington WA 6109	<b>phone</b> <b>fax</b>	<b>(08) 9493 8800</b> (08) 9493 8899			

TM and © Trademarks of Stramit Corporation Pty Limited. ABN 57 005 010 195 trading as Stramit Building Products

A member of the Fletcher Building Group

ZAM® is a registered trademark of Nisshin Steel Co., Ltd.

© Stramit Corporation Pty Limited. November 2015.